



OPERATORS MANUAL

Telex Communications (UK) Ltd,
Klark Teknik Building,
Walter Nash Road,
Kidderminster.
Worcestershire.
DY11 7HJ.
England.

Tel:+44 1562 741515
Fax:+44 1562 745371

Website: www.midasconsoles.com

MIDAS Siena audio mixing console
DOC02-Siena Issue 1.0 - January 2005
© Telex Communciations (UK) Ltd.

In line with the company's policy of continual improvement, specifications and function may be subject to change without notice. This Operators Manual was correct at the time of writing. E&OE.



Important Safety Instructions



These symbols are internationally accepted symbols that warn of potential hazards with electrical products.



The lightning flash with arrowhead symbol, within an equilateral triangle is intended to alert the user to the presence of uninsulated “dangerous voltage” within the product’s enclosure that may be of sufficient magnitude to constitute a risk of electric shock to persons.



The exclamation point within an equilateral triangle is intended to alert the user to the presence of important operating and maintenance (servicing) instructions in the literature accompanying the appliance.

1. Read these instructions.
2. Keep these instructions.
3. Heed all warnings.
4. Follow all instructions.
5. Do not use this apparatus near water.
6. Clean only with a dry cloth.
7. Do not block any of the ventilation openings. Install in accordance with the manufacturers instructions.
8. Do not install near any heat sources such as radiators, heat registers, stoves, or other apparatus (including amplifiers) that produce heat.
9. Do not defeat the safety purpose of the polarized or grounding-type plug. A polarized plug has two blades with one wider than the other. A grounding type plug has two blades and a third grounding prong. The wide blade or the third prong are provided for your safety. If the provided plug does not fit into your outlet, consult an electrician for replacement of the obsolete outlet.
10. Protect the power cord from being walked on or pinched particularly at plugs, convenience receptacles, and the point where they exit from the apparatus.
11. Only use attachments / accessories specified by the manufacturer.
12.  Use only with the cart, stand, tripod, bracket, or table specified by the manufacturer, or sold with the apparatus. When a cart is used, use caution when moving the cart/apparatus combination to avoid injury from tip-over.
13. Unplug this apparatus during lightning storms or when unused for long periods of time.
14. Refer all servicing to qualified personnel. Servicing is required when the apparatus is damaged in any way, such as power-supply cord or plug is damaged, liquid has been spilled or objects have fallen into the apparatus, the apparatus has been exposed to rain or moisture, does not operate normally, or has been dropped.



Telex Communications (UK) Ltd, Klark Teknik Building, Walter Nash Road,
Kidderminster. Worcs. DY11 7HJ. England
Tel: +44 1562 741515 Fax: +44 1562 745371
www.midasconsoles.com www.klarktechnik.com

DECLARATION OF CONFORMITY

We, Telex Communications (UK) Ltd

of, Klark Teknik Building, Walter Nash Road, Kidderminster, Worcestershire, DY11 7HJ.

Declare that a sample of the following product:-

Product Type Number	Product Description	Nominal Voltage (s)	Current	Freq
Siena	Professional Audio Mixing Desk	115V AC 230V AC	2.2A 1.1A	50/60Hz

to which this declaration refers, is in conformity with the following directives and/or standards:-

Directive(s)	Test Standard(s)
<i>Generic Standard using EN55103 Limits and Methods</i>	<i>EN50081/2</i>
<i>Class B Conduct Emissions</i>	<i>EN55103</i>
<i>Class B Radiated Emissions</i>	<i>EN55103</i>
<i>Fast Transient Bursts</i>	<i>EN61000-4-4</i>
<i>Static Discharge</i>	<i>EN61000-4-2</i>
<i>Electrical Safety</i>	<i>EN60065:2002</i>
	<i>UL60065-03 Pending</i>
	<i>CAN/CSA60065-03 Pending</i>
	<i>IEC60065-2001 Pending</i>

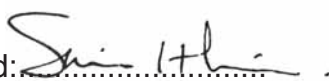
Signed: 
Name: Simon Harrison

Date: 1st February 2005

Authority: Research and Development Director, Telex Communications (UK) Ltd

Attention!

Where applicable, the attention of the specifier, purchaser, installer or user is drawn to special limitations of use which must be observed when these products are taken into service to maintain compliance with the above directives. Details of these special measures and limitations to use are available on request and are available in product manuals.

Welcome

Thank You for using a Midas Siena mixing console. The Siena has been developed to meet the needs of even the most demanding live sound applications. The console delivers both the quality of build and superior audio performance that you would expect from a Midas. All backed up, of course, by the standard Midas Three Year Warranty.

The Siena is an all purpose Monitor or Monitor/Front of House (FOH) hybrid console that is quickly and easily configurable.

Available in 24, 32, 40, 48, 56 and 64 input channel frame sizes, each mono input channel offers microphone and line inputs with four band swept equaliser, direct output and insert send/return. In addition to a master stereo bus, each channel may be assigned onto the console's 16 mix sends, configurable for mono or stereo operation, and featuring independent pre/post switching, level/level or level/pan control.

The 16 mix bus outputs provide the flexibility to generate mono floor monitor or stereo wireless in-ear monitor feeds, with each bus featuring dedicated metering, an insert point and fader level control. In addition, any mix bus from 9 to 16 may be routed and panned onto the stereo master providing sub mixing capabilities for FOH applications.

A comprehensive solo system and five auto mute groups further enhance the Siena's feature set for dealing with the most demanding of applications.

Please take the time to complete and return the registration card and, to obtain the best results, please read this operator's manual.

Finally,

Enjoy your new Midas Siena Console!

Contents

ATTENTION: Installation and power Connections	6
Input Channels	7
Rear Panel and Gain	8
Channel Equalisation	9
Mix sends (Auxiliary sends and groups)	10
Routing to Stereo Master Outputs	11
Metering and Automutes	12
Master Section : Mix Bus Outputs	13
Mix Bus Outputs (Auxiliary Send/ Group Masters)	14
Rear Panel and Metering	15
Direct Input to Mix	16
Mix Bus 1-8 Master Controls	17
Mix bus 9-16 Master Controls	18
Master Section: Stereo Master and Monitoring Controls	
Rear Panel and Metering	19
Direct Input Master Controls	20
Talkback	21
Auto Mute Masters	22
Local Monitoring and Headphone Outputs	23
The Solo System (AFL and PFL)	24
Helix Digital Equaliser and Solo Tracking System	25
Stereo Master Output Controls	26
Setting up the Siena	27
Functional Block Diagrams	35
Mono Input Diagram	36
Mix Output Diagram	37
Master Module Diagram	38
Dimensions and Weights	39
Rear Panel Description	41
Specification and Features	43
Crib Sheet	47

ATTENTION

The following special limitations must be observed in order to maintain safety and electromagnetic compatibility performance.

Power Connection

The console should only be operated with the power supply connected to ground via the ground in the mains connector.

Audio Connections

The console should only be operated with high quality twisted-pair audio cables. All connector shells should be of metal construction so that they provide a screen when connected to the console. All jack connector shells should be connected to the cable screen. All XLR plugs should have pin one (1) connected to the cable screen.

Electric Fields

If the console is operated in an electromagnetic field that is amplitude modulated by an audio frequency signal, the signal to noise ratio may be degraded. Degradation of up to 60dB may be experienced under extreme conditions (3V/m, 90% modulation).

INSTALLATION

Position

The position of the console will vary from venue to venue. However, when positioning the console for front of house usage it is worth placing the console in a position where the sound system used can be heard properly from the mix position. Try to avoid placing the console behind pillars or large objects, or mixing from a level above the speaker position (e.g. from a balcony).

Also try to avoid placing the console near or on any power distribution units or power amplifiers.

Power

If using an external power supply, it should be located as far away from the console as the connecting cable will allow. The power supply should be set for the voltage supply available in your area and plugged into the mains outlet using the cable provided.



THE POWER SUPPLY SHOULD NEVER BE OPERATED WITH THE MAINS EARTH DISCONNECTED

Please note that the power supply contains LETHAL VOLTAGES greatly in excess of the mains voltage and that it's rails can produce extremely large currents which could burn out equipment and wiring if shorted. All testing and servicing should ONLY be carried out by a qualified engineer.

Connections

The console should only be operated with high quality twisted-pair audio cables. All connector shells should be of metal construction so that they provide a screen when connected to the console. All jack connector shells should be connected to the cable screen. All XLR plugs should have pin one (1) connected to the cable screen.

Female XLR

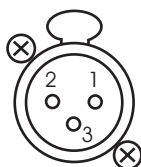

Pin 1 - Screen/Ground
Pin 2 - Hot Signal
Pin 3 - Cold Signal

Male XLR

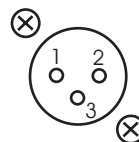

Pin 1 - Screen/Ground
Pin 2 - Hot Signal
Pin 3 - Cold Signal



Quarter Inch Jack

Sleeve
Ring
Tip

TRS Signal

Screen/Ground
Cold Signal
Hot Signal

TRS Insert

Screen/Ground
Insert Return
Insert Send

TRS Headphone

Screen/Ground
Right
Left



Input Channel

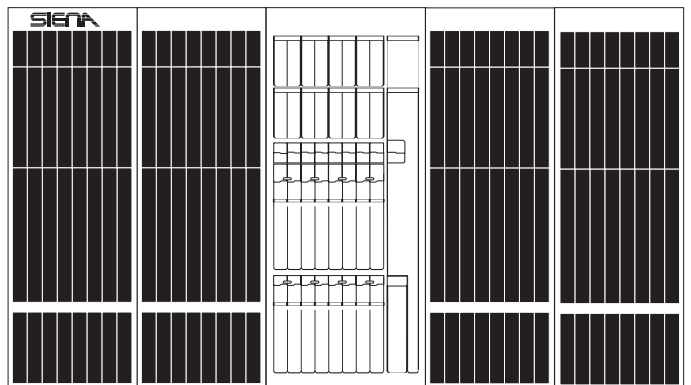

Input Channels

Rear Panel

The Siena channel inputs are located on the rear of the console. Each channel provides:

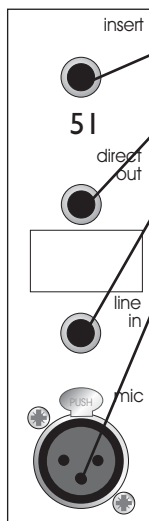

- one insert point on a single TRS jack socket.
- one direct output on a single impedance balanced quarter-inch jack socket
- one line in quarter-inch TRS balanced jack socket
- one mic balanced XLR female

The channel **insert point** is unbalanced and requires a conventionally wired insert lead where:

- Tip** - Channel Signal Send
- Ring** - Channel Signal Return
- Sleeve** - Signal Common Ground

The direct out and insert points operate at a nominal level of 0dBu.

Balanced XLR and Jack inputs are conventionally wired:

- XLR** - 1. Screen - 2. Hot Signal - 3. Cold Signal
- TRS** - T. Hot Signal - R. Cold Signal - S. Screen

The console's **direct outputs** are set post fader as standard. However, an internal jumper may be set to offer one of four alternatives:

- Pre EQ, insert, channel fader and mute.
- Pre EQ and channel fader, but post insert and mute.
- Post EQ and insert, but pre channel fader and mute.
- Pre channel fader, but post insert, EQ and mute.

Please refer to the service manual or contact your authorised Midas service agent for more details on setting this option.

Front Panel

All input channels on the Siena console are mono and the actual number available will depend on your choice of frame.

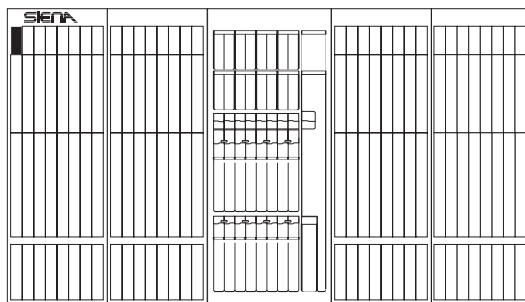

48V Power - When depressed, the Siena will apply 48 volts phantom power to the microphone input. This is used to power condenser microphones, direct inject boxes and other devices that require phantom power.

The red phantom LED will light to indicate that 48V phantom is in operation.

Mic Ø - The mic phase switch, when depressed, causes a 180 degree phase change (with respect to the input signal) to occur in the input amplifier such that the channel signal will have opposite polarity to the input signal.

The mic phase switch is commonly needed where two microphones are used facing each other (for example when using a microphone on both the top and bottom of a snare drum). Ordinarily the two microphones would be out of phase causing cancellation when the console sums the two signals into the output. Reversing the phase of one signal causes the microphones to have the same phase and no cancellation.

Hi-Pass - The Hi-Pass switch enables the high pass filter in the channel signal path. The filter is located before the insert point and channel equaliser, and is ideal for removing low frequency handling noise, bass rumble or mains hum.

-15dB Pad - The Pad switch provides 15dB attenuation to the input signal allowing for the connection of high output microphones and line level signals without overloading the channel input amplifier. Overloads are indicated on the in-channel meter by the red LED at the top.

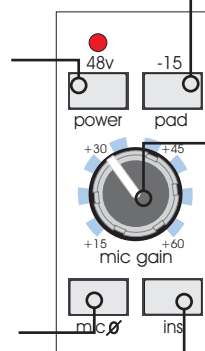

Mic Gain - The mic gain is continuously variable from +15dB to +60dB (0dB to +45dB with the Pad enabled). The actual value of the gain required will depend upon the source and should ideally be set such that peaks in level on the input should not cause the input amplifier to overload (occasional peaks of +12dB is okay, +18dB is too high).

Ins - The ins switch enables the channel insert point by connecting the insert return to the channel signal path. The insert is switched into circuit before the EQ section, and may be used to apply external processing such as compression, gating or effects to the channel signal.

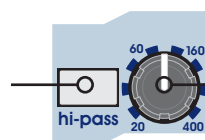

High Pass Frequency - The cutoff frequency of the high pass filter is continuously variable from 20Hz to 400Hz.

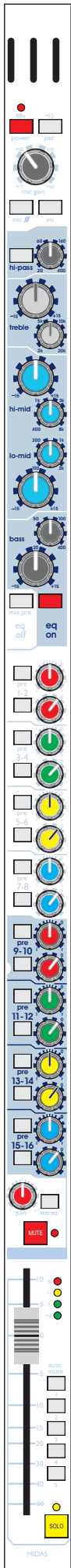

Channel Equalisation

Each input channel of the Siena has a four (4) band sweep EQ allowing tonal control over the input signal.

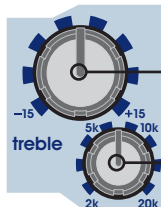
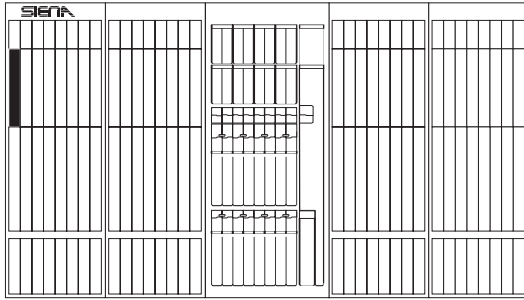

Treble (Gain) - The gain of the treble equaliser is continuously variable from -15dB to +15dB with a centre detent at 0dB.

Treble (frequency) - The centre frequency of the treble equaliser is continuously variable from 2kHz to 20kHz.

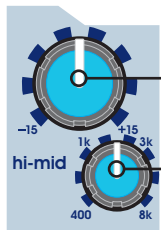

Hi-Mid (Gain) - The gain of the hi-mid equaliser is continuously variable from -15dB to +15dB with a centre detent at 0dB.

Hi-Mid (frequency) - The centre frequency of the hi-mid equaliser is continuously variable from 400Hz to 8kHz.

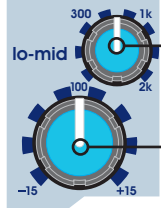

Lo-Mid (frequency) - The centre frequency of the lo-mid equaliser is continuously variable from 100Hz to 2kHz.

Lo-Mid (Gain) - The gain of the lo-mid equaliser is continuously variable from -15dB to +15dB with a centre detent at 0dB.

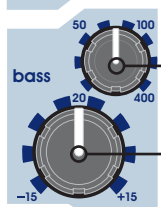

Bass (frequency) - The centre frequency of the bass equaliser is continuously variable from 20Hz to 400Hz.

Bass (Gain) - The gain of the bass equaliser is continuously variable from -15dB to +15dB with a centre detent at 0dB.

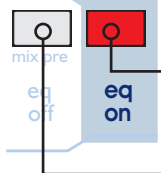

EQ On - The Equaliser can be enabled by depressing the EQ On switch. Otherwise changes on the Equaliser controls have no effect. This can be used to compare the sound with and without EQ during sound check.

EQ Off (mix pre) - Depressing the EQ Off (mix pre) switch causes pre fader sends onto mix buses 1-16 to be sourced before the channel equaliser. For example, you may wish to EQ the channel signal feeding the master stereo bus while deriving mix sends pre EQ. Note: post fader sends are always post EQ.

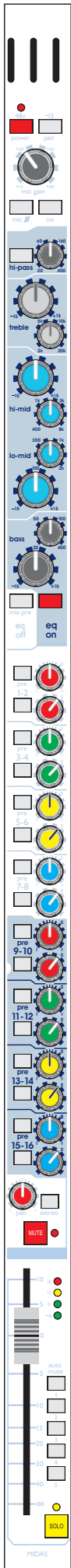

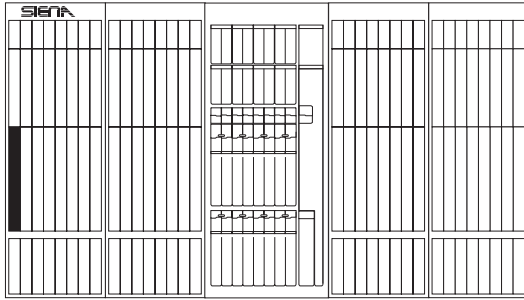
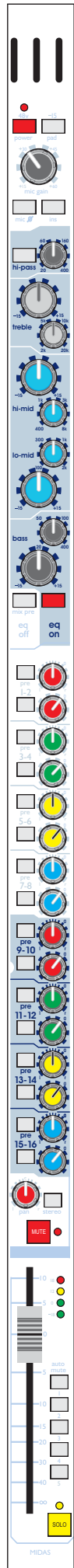

Mix Sends (Auxiliary Sends and Groups)

For maximum flexibility, the Siena has 16 mix busses for use as auxiliary sends or groups. In addition, any pair of busses may be configured for mono or stereo operation.

For example, today you may be using the console purely as a monitor desk, in which case you probably want to generate as many auxiliary sends as possible. In addition, you may require both mono and stereo mixes to feed a mixture of floor monitors and wireless in-ear monitoring. By configuring any odd/even pair of the Siena's mix busses for stereo operation, you have complete flexibility over the console layout.

Alternatively, in a hybrid FOH/monitor application, you may wish to create both auxiliary sends and group masters. Note that the controls for mix outputs 9-16 vary slightly from those for mix outputs 1-8. This is due to the fact that mix bus outputs 9-16 may be routed, and panned, onto the stereo master bus. Therefore, mix busses 9-16 are ideal for use as group outputs as they may be output separately from the console and/or summed onto the stereo master for a FOH mix. For these reasons, use mix busses 1-8 for auxiliary sends and 9-16 to create audio sub groups when working in a hybrid FOH/Monitor application.

Pre Fade mix sends are sourced after the channel insert, mute and EQ but before the channel fader. They will also be fed pre EQ if the **mix pre** (EQ Off) switch is depressed. As a result, the actual level sent to the aux bus is proportional to the mix send control only.

Post Fade mix sends are sourced after the channel insert, mute, EQ and channel fader. As a result, the actual level sent to the mix bus is proportional to the aux send control AND the channel fader.

Please note that, for illustration purposes, mix sends 1 and 2, only, are shown below. However, all 16 mix sends work in the same manner. In addition, to help locate the correct send more easily, sends 9 to 16 are highlighted by a lighter background panel colour.

Mix Send Pre/Post Switching Any mix send may be sourced pre fader by depressing the **pre** button. In this mode, the channel fader has no effect upon the level of the signal sent to the mix bus.

Note: both pre and post fade sends are muted when the channel mute is enabled.

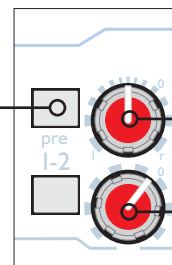

Mix Send Level - The mix send level is continuously variable from off (-inf) to +6dB.

Stereo Send Operation

Stereo sends are configured globally for each odd/even pair of mix busses by the recessed **stereo** switches located beside each pair of master faders in the Master section. Please refer to Page 17 for more details.

If mix busses are configured for stereo operation, the two rotary controls and **pre** switches behave slightly differently from mono mix sends to provide stereo pan, send level and pre/post fader control:

When configured for stereo operation, the upper **pre** switch is inactive.

Mix Send Pre/Post Switching Use the lower of the two **pre** switches to switch the stereo send pre fader. In this mode, the channel fader has no effect upon the level of the signal sent to the mix bus.

Note: both pre and post fade sends are muted when the channel mute is enabled.

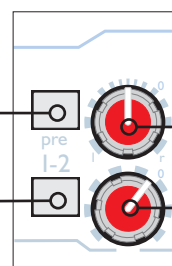

Mix Send Pan The mono signal from the channel may be positioned within the stereo field using the left/right pan control. Turn the control fully anticlockwise to pan signal to the left (mix bus 1) or clockwise to pan to the right (mix bus 2). Adjustment between hard left and hard right is continuous.

Note: the pan control obeys a constant power law (i.e. -3db at the centre.)

Mix Send Level - The mix send level is continuously variable from off (-inf) to +6dB.

Routing to the Stereo Master Output

In addition to the 16 mix bus sends, Siena features a stereo master output.

Typically, this would be used to generate the Front of House (FOH) mix for hybrid FOH/monitor applications. In stand alone monitor applications, the master output may remain unused or provide an additional stereo output bus.

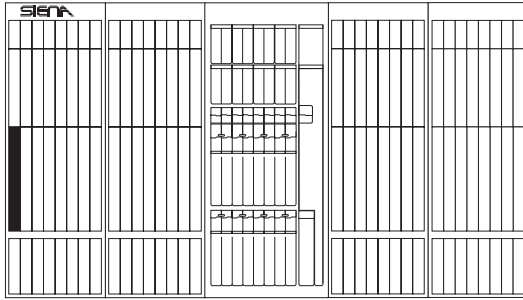

Pan The mono signal from the channel may be positioned within the stereo field using the channel pan control. Turn the control fully anticlockwise to pan signal to the left or clockwise to pan to the right. Adjustment between hard left and hard right is continuous, with a centre detent.

Note: the pan control obeys a constant power law (i.e. -3db at the centre.)

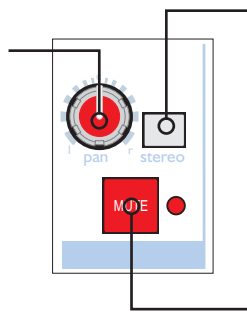

Stereo Depressing the **stereo** switch routes the channel signal onto the stereo (master left and right) bus. The signal is sourced post EQ, pan, mute and fader.

Mute - The **MUTE** switch mutes the channel signal feeding all 16 mix bus (pre or post fader) and stereo master bus outputs. However, signal will still be sent to the insert send. The mute status of the channel is indicated by the corresponding mute LED.

Note: the mute switch may be controlled from any of the five Auto Mute masters, see Page 22 for details.

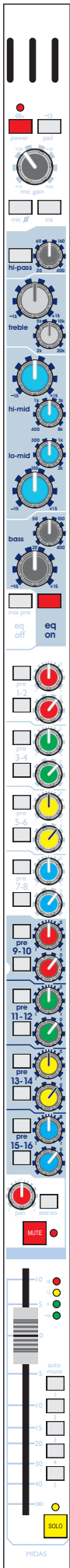

Input Channels

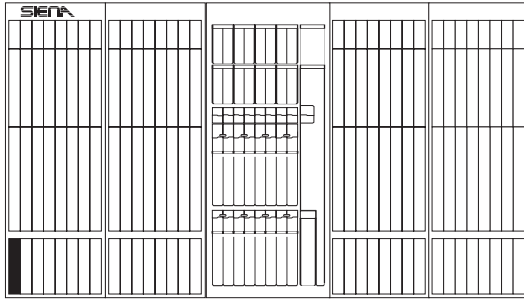
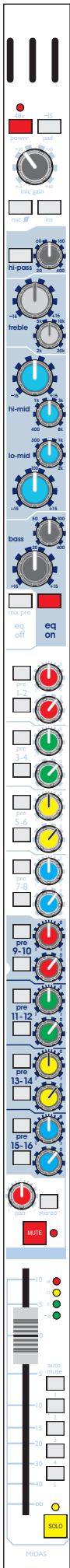

Channel Fader - The channel fader allows for continuous adjustment of the channel level from off (-inf) to +10dB. At 0dB, the output of the channel to the stereo master and 16 Mix busses will be at unity gain (i.e. no boost or cut in level from the input).

Solo - When selected, the channel SOLO switch routes signal onto the After Fade Listen (AFL) and Pre Fade Listen (PFL) outputs. The solo LED indicator illuminates to show that the channel solo is active.

Depending on the AFL and PFL selector in the master section, you may now be listening to the channel signal after the fader (AFL) or pre fader (PFL) on either the main monitor or headphone outputs.

Note: the AFL bus is a stereo bus; the PFL bus is mono. For more details on AFL and PFL monitoring, please refer to the 'The Solo System' on page 24.

4 LED Meter - The 4 LED meter indicates the channel's peak signal level, measured after the insert point and EQ, but before the channel fader and mute. This provides a confidence meter, allowing the user to monitor the input signal prior to opening the fader, or deselecting the channel mute.

With the insert and EQ disabled, the meter shows the peak signal level in four stages:

- +18dB - Overload (Peak)
- +12dB - High Level
- 0dB - Normal Level
- 18dB - Signal Present

The in-channel meter is especially useful when setting the microphone gain of a channel. Also, as the meter is post EQ, it is possible to see the effect that the channel equalisation has upon the level.

For optimal performance, the level for input channels should be around +6db. Therefore, ideally, the in-line meters should show the 0dB LED illuminated consistently when signal is present, with occasional illumination of the +12dB LED.

Note: it may be necessary to turn the input gain down when excessive EQ is used to prevent the channel from overloading.

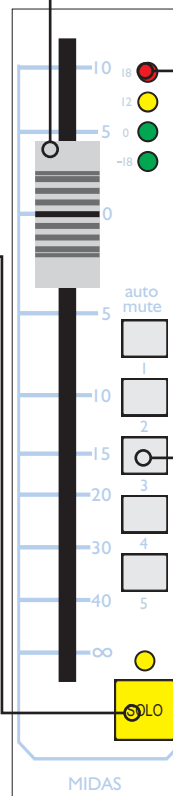

Auto Mute 1, 2, 3, 4 & 5 The Siena has five auto mute groups that can be controlled from the master section of the console. To assign an input channel to an auto mute group, switch in the desired auto mute switch.

Note: auto mute 5 is also available on the 16 mix and stereo output masters and, therefore, you may wish to reserve this group for dealing with output mute functions.

Commonly, the auto mute groups are used to provide easy muting of similar channels. For example:

Channels

- Drum Mics
- Choir Overheads
- Orchestra Parts

Reason

- Allows the engineer to mute the whole drum kit at once.
- Allows the engineer to quickly remove all choir mics at once
- Allows the engineer to zone mics together (e.g. Brass, Strings, etc.) and mute sections together if they were not playing.

Note: the auto mute groups and the individual channel mutes work like a logical OR where any single or combination of mutes will mute the channel output. This means, for example, that if channel 1 is assigned to auto mute group 4, and both the auto mute master and channel mute are active, the output of the channel will remain muted until *both* the auto mute master and individual channel mute are deactivated.

SIENA

Master Section

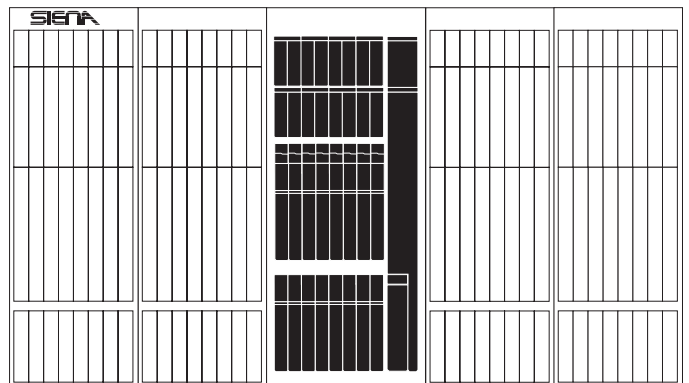

The Master Section of the Siena console is divided into two principal areas:

On the left hand side of the panel, the two rows of eight faders, associated controls and metering provide output control for the console's 16 mix busses. Typically, these 16 mix bus outputs are used for auxiliary send masters and/or group outputs.

On the right hand side of the section, you will find the stereo master output, local and headphone monitoring, master AFL/PFL selector, talkback, tone, direct input and auto mute master controls.

Mix Bus Outputs (Auxiliary Send/Group Masters)

The Siena has 16 mix bus outputs for use as auxiliary sends or group outputs. The console uses a generic approach to the mix bus structure to enable it to cover a wide range of applications.

For example, today you may be using the console purely as a monitor desk, in which case you probably want to generate as many auxiliary sends as possible. In addition, you may require both mono and stereo monitor mixes to feed a mixture of floor monitors and wireless in-ear monitoring. By configuring any odd/even pair of the Siena's mix busses for stereo operation, you have complete flexibility over the console layout.

Alternatively, in a hybrid FOH/monitor application, you may wish to create both auxiliary sends and group masters. You may already have noticed that the controls for mix outputs 9-16 vary slightly from those for mix outputs 1-8. This is due to the fact that mix bus outputs 9-16 may be routed, and panned, onto the stereo master bus. Therefore, mix busses 9-16 are ideal for use as group outputs as they may be output separately from the console and/or summed onto the stereo master for a FOH mix. For these reasons, use mix busses 1-8 for auxiliary sends and 9-16 to create audio sub groups when working in a hybrid FOH/Monitor application.



Master Section: Mix Bus Outputs

Rear Panel

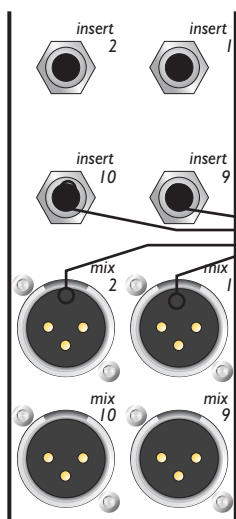

Each of mix bus outputs 1-16 may be connected to external equipment by means of one single balanced male XLR socket (0dBu nominal level).

In addition to this, each mix bus provides an insert send and return on a single unbalanced quarter-inch TRS jack conventionally wired (0dBu nominal level).

Mix Bus Inserts
Mix Bus Outputs

XLR Sockets

1 - Screen 2 - Signal Hot 3 - Signal Cold

TRS Insert Jacks

T - Signal Send R - Signal Return S - Screen

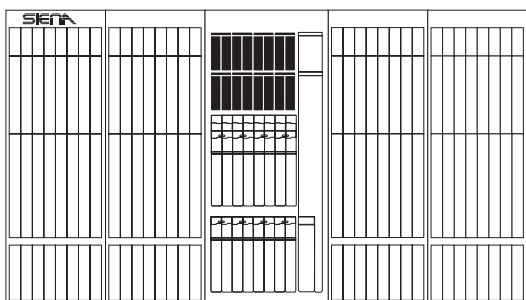
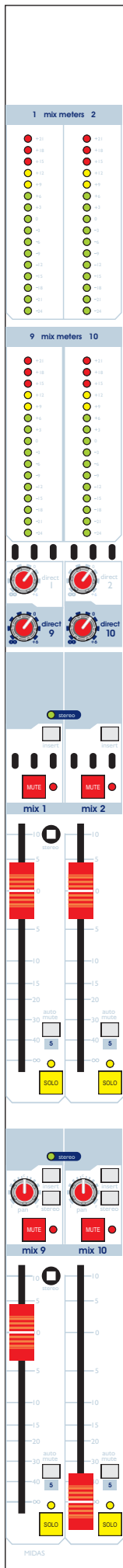

Mix Bus Outputs (Auxiliary Send/Group Masters)

Metering

On Siena, every one of the 16 mix bus outputs features its own dedicated LED meter, providing a constant overview of every mix leaving the console.

The meters are arranged in pairs so that when busses are configured for stereo operation, metering may be clearly identified. In addition, they are laid out in two rows reflecting the 1-8 and 9-16 layout of the master faders lower down the module.

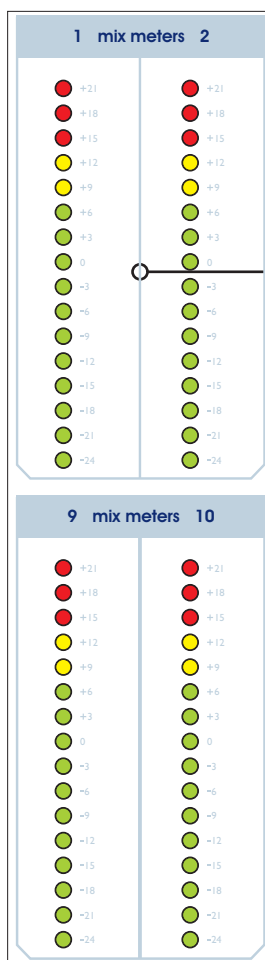

Each LED meter indicates the peak signal level of the mix bus output from -24dB to +21dB in 3 dB steps. Signal is measured after the master fader and mute providing a true representation of the level leaving the mix output XLR on the rear of the console.

Master Section: Mix Bus Outputs

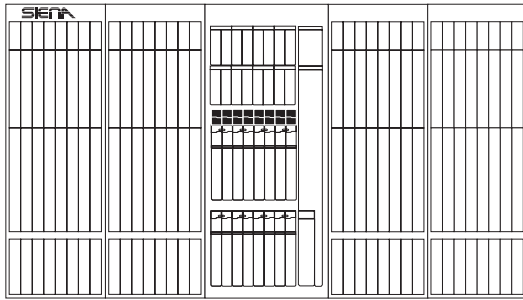

Direct Input to Mix

In addition to the console's input channels, Siena features a single stereo direct input (line level) which may be added to any of the 16 mix bus outputs or stereo master.

A common application is to use the direct input as a stereo effects return. For example, you may be using an auxiliary send to feed signals to an external reverberation unit. Connecting the reverb return to the direct input allows you to add reverb back to each of your artist's monitor sends, without needing to use an additional pair of input channels for this purpose.

The direct input is a stereo line level input available on the rear panel of the master section. It features its own input level control, solo and mute facilities. For more details on these controls and connections, please refer to Page 20.

Following the input stage, the **direct 1** to **direct 16** controls adjust the amount of direct input signal added to the each of the 16 mix busses.

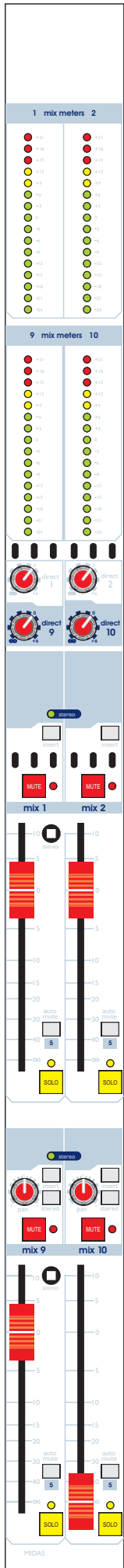

Direct Input Level to Mix - Controls the direct input level added to each mix bus output. Level may be adjusted continuously from off (-inf) to +6dB.

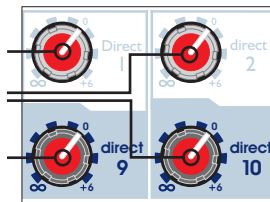

The signal added to each mix bus is affected by the mono/stereo configuration of each mix bus. For example, if mix busses 1 and 2 are configured for stereo operation, bus 1 is fed from direct input left and bus 2 from direct input right according to the level settings of the **direct 1** and **direct 2** controls. However, the left and right direct input signals are also summed, so that if say mix bus 3 is configured as a mono bus, it is the mono sum which is added to this output.

Note: a -3dB offset is applied to the mono sum. This automatic level compensation ensures that when adding the direct input to a mixture of mono and stereo mix busses, similar direct level settings may be applied without any perceptible difference in level.

Master Section: Mix Bus Outputs

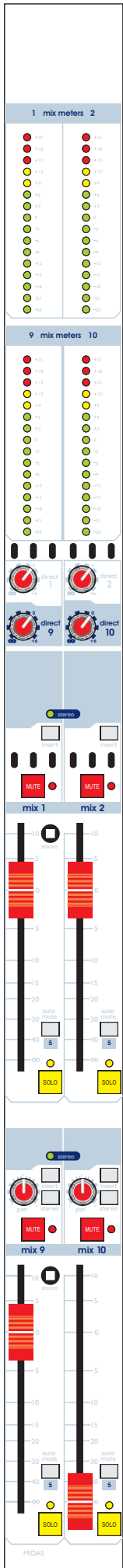

Auxiliary Send/Group Masters

The master controls for mix bus outputs 1-8 vary slightly from those offered on mix bus outputs 9-16. This is due to the fact that mix busses 9-16 offer the additional feature of routing, and panning, onto the stereo master bus. This makes mix busses 9-16 ideal for use as group outputs in a hybrid FOH/Monitor application.

Mix Bus 1-8 Master Controls

First, let's deal with the controls for mix bus masters 1-8. Note that for clarity, only the first pair of mix bus outputs are illustrated on the front panel drawings below.

Stereo LED Illuminates when mix busses are linked for stereo operation, see below.

Mute The **MUTE** switch mutes the mix bus output signal post fader. (i.e. signal is muted at all points except the mix bus insert send and PFL bus). The mute status is indicated by the corresponding mute LED.

Note: the mute switch may be controlled by Auto Mute master 5, see below.

Fader The fader provides continuous adjustment of the mix bus output level from off (-inf) to +10dB.

Auto Mute 5 Depress this switch to assign any of the 16 mix bus output mutes to auto mute group 5. The Siena has five auto mute groups that can be controlled from the master section of the console. Any input channel may be assigned to auto mute groups 1-4; both input channels and mix bus masters may be assigned to group 5.

Solo When selected, the mix bus **SOLO** switch routes signal onto the stereo After Fade Listen (AFL) and mono Pre Fade Listen (PFL) busses. The solo LED indicator illuminates to show that the mix bus solo is active. Depending on the AFL/PFL selector in the master section, you may now be listening to the mix bus output signal after the fader (AFL) or pre fader (PFL) on your local monitoring or headphone outputs.

Any of the 16 mix bus master **SOLO** switches may also trigger auto solo messages on an external Helix digital equaliser via the console's Solo Tracking System. For more details, please refer to Page 25.

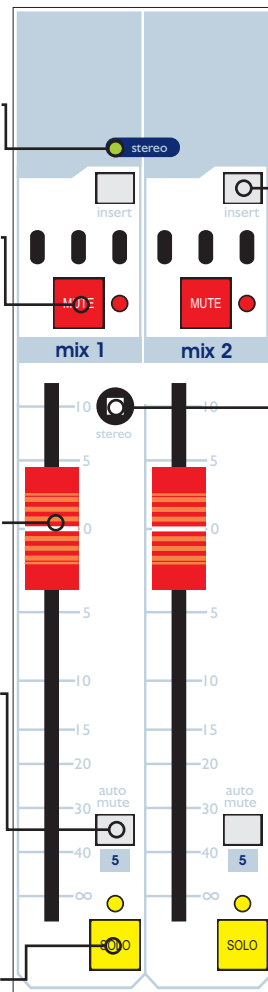

Insert When depressed, the corresponding mix bus insert return is inserted pre fader into the mix bus output signal path.

Stereo/Mono Use the recessed **stereo** switch to link the odd/even pair of mix busses for stereo operation. When set for stereo, the following operational changes occur:

On each **input channel**, separate level and pan controls become available for the stereo mix send. To switch the stereo send pre fader, use the lower of the two channel **pre** switches. (The upper **pre** switch is inactive in stereo mode.) Please see Page 10 for more details on input channel controls.

The solos for a stereo bus are adjusted such that odd bus solos route signal to AFL left and even bus solos route signal to AFL right. When mix busses are configured for mono operation, solos are summed in mono onto the AFL output.

All other controls (e.g. fader output level, mute, solo and insert return switching) remain independent for the left and right sides of the mix bus master.

Master Section: Mix Bus Outputs

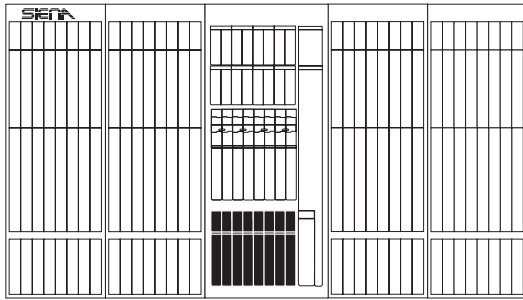

Auxiliary Send/Group Masters

Mix Bus 9-16 Master Controls

The master controls for mix bus outputs 9-16 are identical to those for mix bus outputs 1-8 with the addition of the following features:

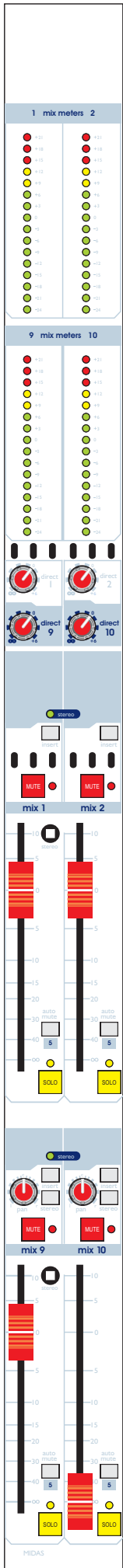

Route to Stereo Master Depressing the **stereo** switch routes the mix bus output onto the stereo (master left and right) bus. The signal is sourced post insert, pan, mute and fader.

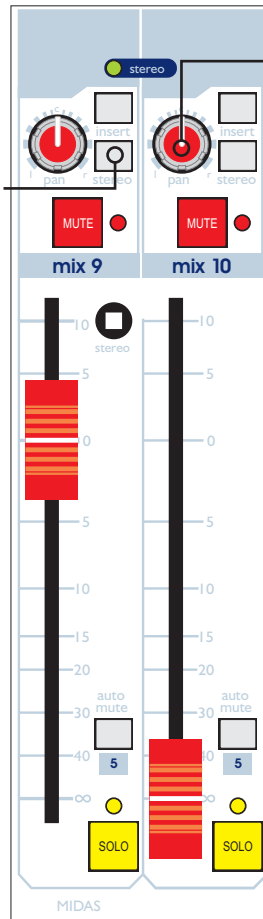

Pan The signal from the mix bus output may be positioned within the stereo master field using the pan control. Turn the control fully anticlockwise to pan signal to the left or clockwise to pan to the right. Adjustment between hard left and hard right is continuous, with a centre detent.

Note: the pan control obeys a constant power law (i.e. -3db at the centre.)

These additional features make mix busses 9-16 ideal for creating sub mix groups from the console.

Master Section: Stereo Master & Monitoring Controls

Rear Panel

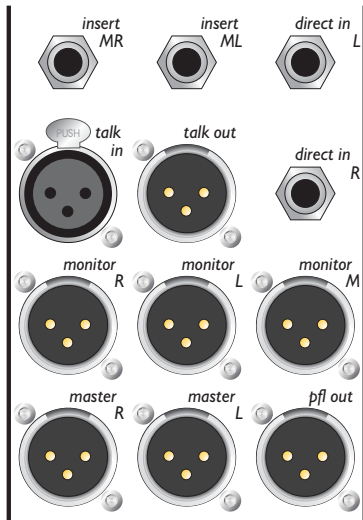

The Siena's stereo master and monitoring outputs are located on the rear of the console and provide:

Output	Source	Connector	Nom. Level
Master L	Left Bus	XLR Male (Bal)	0dBu
Master R	Right Bus	XLR Male (Bal)	0dBu
PFL Out	PFL Solo Bus	XLR Male (Bal)	0dBu
Monitor L	Local Monitor Left	XLR Male (Bal)	0dBu
Monitor R	Local Monitor Right	XLR Male (Bal)	0dBu
Monitor M	Local Monitor Mono	XLR Male (Bal)	0dBu
Talk Out	Talk Bus	XLR Male (Bal)	0dBu

Also provided are Master L and R insert points (Insert MR and Insert ML) on conventionally wired quarter-inch TRS jacks (0dBu nominal level), a stereo direct input (Direct In L and Direct In R) on line level balanced jack inputs and Talk Input (Male XLR balanced, 0dBu nominal level).

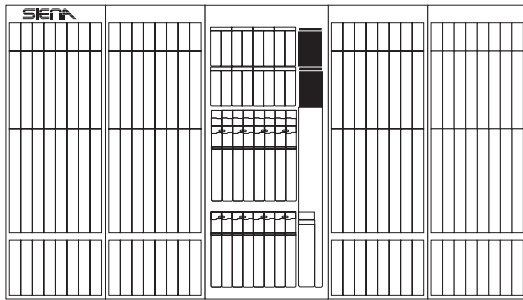

Stereo Master and Monitoring Controls

Metering

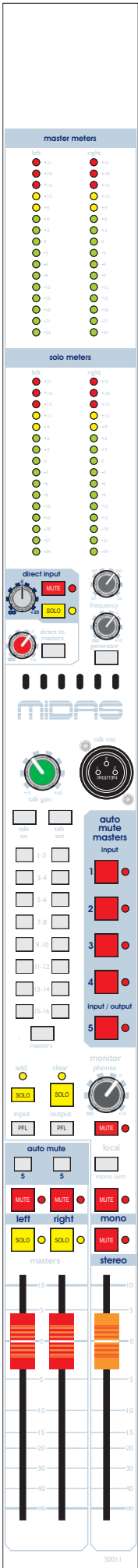

Master Meters The two master meters indicate the peak signal level of the left and right master outputs from -24dB to +21dB in 3 dB steps. Signal is measured after the master fader and mute providing a true representation of the level leaving the output on the rear of the console.

Solo Meters The two solo meters always follow what is being monitored on the local monitor and headphone outputs. Therefore, they will meter either stereo AFL or mono PFL signals depending on the solo selections across the console and master AFL/PFL selector. Please refer to Page 24 for more details on the console's solo system.

Note: when in PFL mode, the mono PFL bus appears on the left and right Solo meters.

The solo meters are pre monitor and phones mute and level control, and so are unaffected by changes in headphone or local monitoring level.

Master Section: Stereo Master & Monitoring Controls

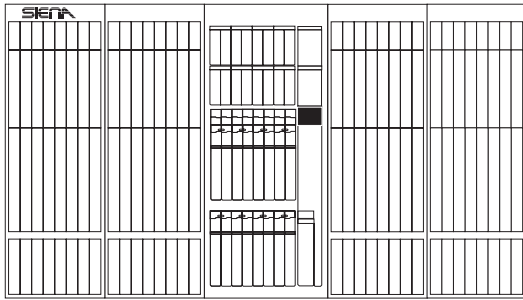

Direct Input Master Controls

In addition to the console's input channels, Siena features a single stereo direct input (line level) which may be added to any of the 16 mix bus outputs or stereo master.

A common application is to use the direct input as a stereo effects return. For example, you may be using an auxiliary send to feed signals to an external reverberation unit. Connecting the reverb return to the direct input allows you to add reverb back to each of your artist's monitor sends, without needing to use an additional pair of input channels for this purpose.

The direct input is a stereo line level feed available on the rear panel of the master section. It features its own input level control, solo and mute facilities as follows:

Direct Input Level The direct input level provides continuous adjustment of input level from off (-inf) to +20dB. Use this control to set the optimum input level for the stereo direct input.

Direct to Masters Level This level control sets the level of the direct input applied to the stereo master bus when the Direct to Masters switch is depressed. Level may be adjusted from off (-inf) to +6dB.

Note: the **direct 1** to **direct 16** controls located above the mix bus output master faders adjust the amount of direct input signal added to the each of the 16 mix busses. For more details on these controls, please refer to Page 16.

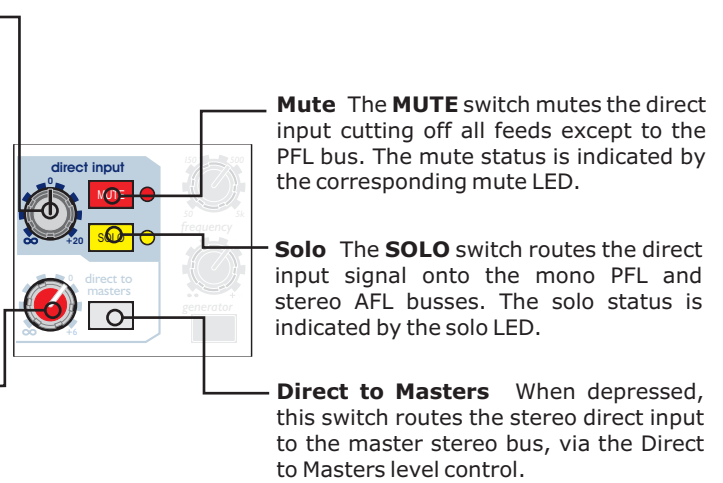

Tone Generator (Oscillator)

The Siena provides an internal tone generator which may be routed to any of the console's 16 mix bus and stereo master outputs.

When enabled, the output of the tone generator is added to the talk bus where it may be combined with the console's talk mic and external talk inputs. The combined signals are then routed to any of the bus masters using the 'talk to mix' and 'talk to masters' switches located in the Talkback section.

Note: to route only the tone generator to a mix bus output or stereo master, without talkback, make sure that both the **talk on** and **talk ext** switches are disabled.

Generator On Enables the tone generator.

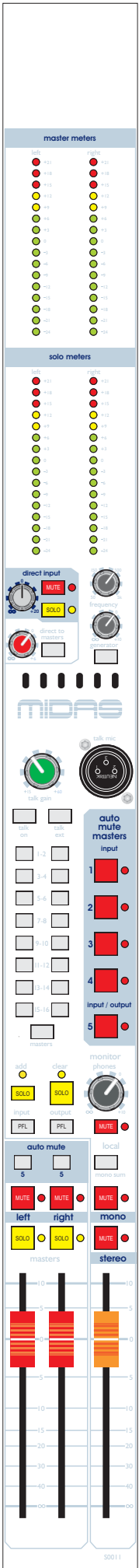
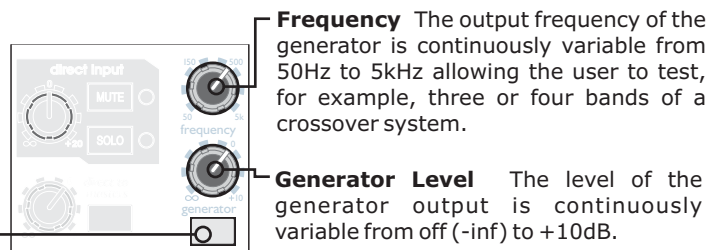

Master Section: Stereo Master & Monitoring Controls

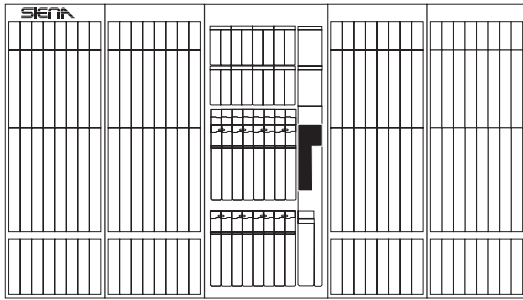

Talkback

The Siena provides talkback which may be routed to any of the console's 16 mix bus and stereo master outputs. There are two options for connecting talkback sources to the console:

On the front panel, a conveniently located internal talk mic socket, supplied with 48V phantom power, allows connection of a condenser microphone.

On the rear panel of the master section, the **talk in** XLR allows connection of an external talkback source.

Each of these circuits is individually routed to the talk bus, and combined with the tone generator if it is enabled. The combined talkback and tone signals may then be routed to any of the console's 16 mix bus and stereo master outputs using the 'talk to mix' and 'talk to masters' switches shown below.

Note: to route only talkback to a mix bus output or stereo master, without the tone generator, make sure that the **Generator On** switch is disabled.

In addition to routing talkback to the console's mix bus and master outputs, the **talk out** circuit available on the rear panel of the master section, provides an output of the talk bus enabling the combined talkback and tone signals to be output to an external communications system.

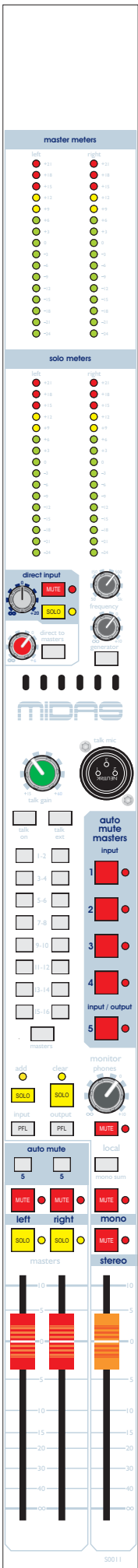

Talk Mic Gain The gain of the internal talk mic input is continuously variable from +15dB to +60dB.

Talk On When depressed, the internal talk mic input is enabled and routed to the talk bus. In addition, all local monitor outputs are attenuated by 20dB to help prevent feedback.

Talk to Mix Bus Outputs (1-2, 3-4, etc.) The 16 talk to mix switches route the combined talkback and tone generator signals individually to each of the console's 16 mix busses.

Talk to Masters The **masters** switch routes the combined talkback and tone generator signals to the console's stereo master.

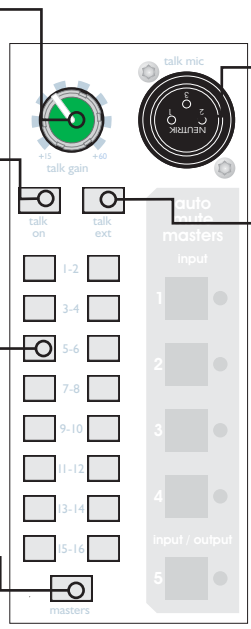

Talk Mic The internal talk mic socket is a conventionally wired XLR male and is supplied with 48V phantom power allowing the connection of condenser microphones for engineer talkback.

Talk External The **talk ext** switch enables both the **talk in** and **talk out** connections on the rear panel of the master section. This adds the external talkback source connected to the **talk in** XLR to the talk bus. It also activates the **talk out** connection providing an output feed from the talk bus.

Master Section: Stereo Master & Monitoring Controls

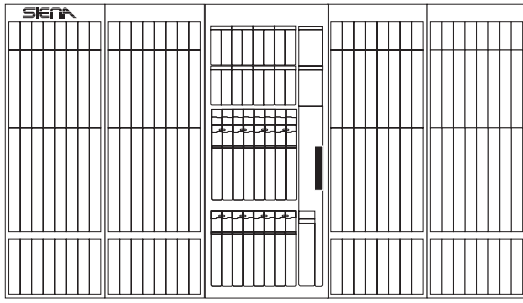

Auto Mute Masters

The Siena provides five auto mute groups commonly used to provide easy muting of similar channels. For example:

Channels	Reason
Drum Mics	Allows the engineer to mute the whole drum kit at once.
Choir Overheads	Allows the engineer to quickly remove all choir mics at once
Orchestra Parts	Allows the engineer to zone mics together (e.g. Brass, Strings, etc.) and mute sections together if they were not playing.

Any input channel may be assigned to auto mute groups 1-4; both input channels and mix bus masters may be assigned to group 5, therefore, you may wish to reserve this group for dealing with output mute functions.

For example, when using the console to run monitors during a live concert, there may be one song where most of the band will leave the stage. During this part of the show, monitor sends are only needed for one or two performers. By selecting auto mute 5 on all of the other band members' auxiliary send masters, you may mute these monitor feeds with one switch press auto mute master 5.

The auto mute master switches located in the master section activate each auto mute group as follows:

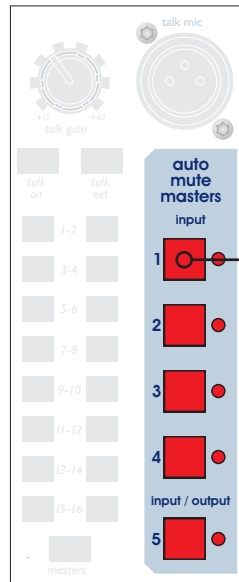
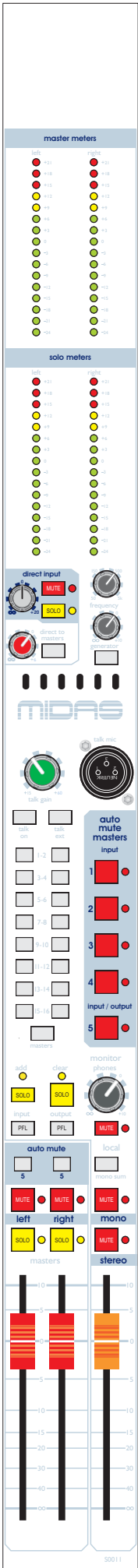

Auto Mute Masters 1, 2, 3, 4 & 5
Press the corresponding auto mute master switch to mute all input channels and/or bus masters included within the auto mute group (1 through 5). The auto mute master status is indicated by the corresponding LED.

Note: don't forget to check the status of your auto mute masters and auto mute group assignments carefully, as any mutes on assigned input channels or bus outputs will not be released until the auto mute master is disabled!

Master Section: Stereo Master & Monitoring Controls

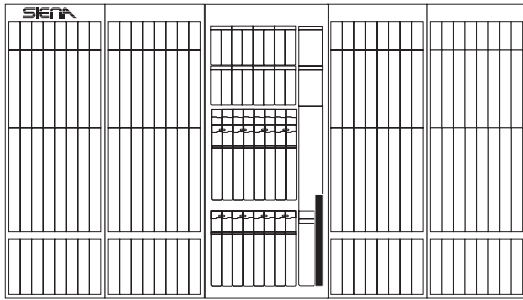

Local Monitoring and Headphone Outputs

The Siena provides local stereo and mono monitor outputs, stereo headphone and separate PFL output. Typically, each of these outputs is provided for the following applications:

Output	Format	Connection	Application
Local Monitor L/R	Stereo	Rear Panel	For connection of local stereo loudspeakers.
Local Monitor M	Mono	Rear Panel	For connection of a local mono loudspeaker.
Headphone (Phones)	Stereo	Arm Rest	For connection of stereo headphones.
PFL Out	Mono	Rear Panel console.	For linking the PFL output of the Siena to another

Tip: when running monitors, you may wish to listen to your mono floor monitor feeds on a separate speaker to your stereo in-ear monitoring so that you know what the artist is hearing from each system. Connect a pair of stereo speakers to the **Local Monitor L/R** output and a separate mono speaker to the **Local Monitor M** output. Now solo the mix bus masters feeding both the in-ear monitoring and floor monitors. Using the mono and stereo local monitor **MUTE** switches, you will now be able to mute the floor monitor speaker to listen to the stereo in-ear monitor feed or vice versa.

Do not confuse the **Local Monitor M** output with the **PFL Output** connection, as the PFL Out is always active and does not feature level or mute control. This is because the PFL Out is typically used to connect the PFL bus to a second console. For example, if the Siena is working with the support band, it may be necessary to feed its PFL output to the main band's console.

By default, you will be monitoring the AFL bus on the local monitor and headphone outputs. However, you may choose to monitor the PFL bus for either inputs and/or outputs using the master AFL/PFL selector, see 'The Solo System' on Page 24 for more details.

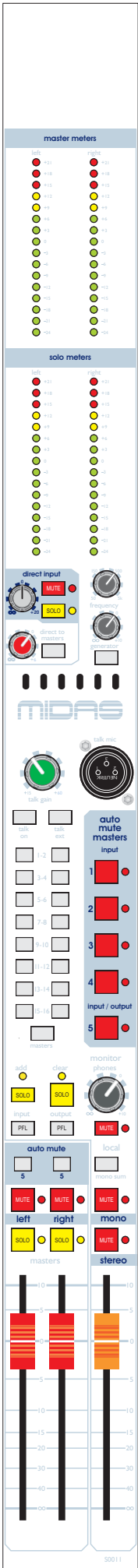

Local Monitor Mono Mute The mono **MUTE** switch mutes the Monitor M output. The mute status is indicated by the corresponding LED.

Local Monitor Stereo Mute The stereo **MUTE** switch mutes the Monitor L and Monitor R outputs. The mute status is indicated by the corresponding LED.

Local Monitor Fader The local monitor fader allows for continuous adjustment of both the mono and stereo local monitor outputs (Monitor L, Monitor R and Monitor M) from off (-inf) to +10dB.

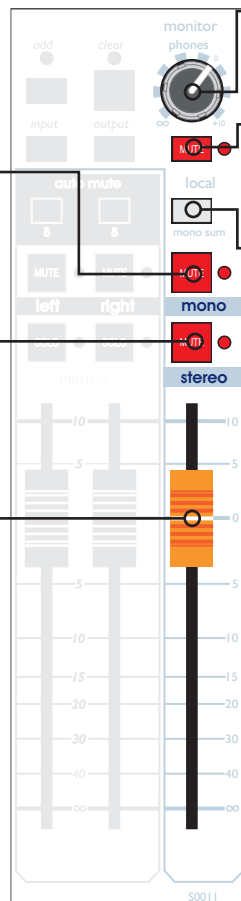

Phones Level The level of the headphone output is continuously variable from off (-inf) to +20dB.

Phones Mute The **MUTE** switch mutes the headphone output. The mute status is indicated by the corresponding LED.

Mono Sum The **mono sum** switch sums the left and right monitor signals feeding both the local monitor and headphone outputs so that the stereo output may be checked for phasing issues and mono compatibility

Master Section: Stereo Master & Monitoring Controls

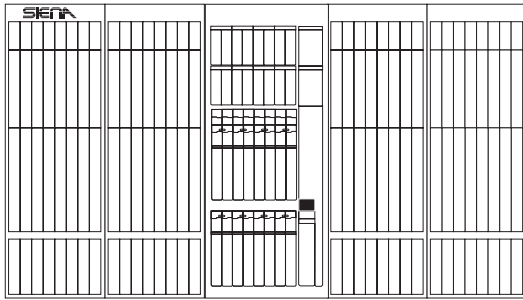

The Solo System (AFL and PFL)

Siena's hierarchical solo system and master AFL/PFL selector provides the flexibility to monitor signals pre fade (PFL) or post fade (AFL) quickly and easily.

By default, you will be monitoring channels or outputs in AFL on the local monitor and headphone outputs when you press a SOLO switch. To change to PFL monitoring, use the master AFL/PFL selector as described below.

Normally, solo switches intercancel. However, if you press a number of SOLO switches in less than a second, they will latch on together. This provides a quick way of listening to a number of channels or outputs. For example, to solo both the left and right sides of a stereo mix bus output. Alternatively, you can force the console solos to always be additive by enabling the **Solo Add** mode. Note: in this mode, solos are prioritised according to the type of input or output - see 'Solo Hierarchy' below for more details.

Note also that the master stereo left and right SOLO switches are both mechanically latching. By selecting these two switches you can set the default solo state to monitor the stereo master output whenever other solos are cleared.

Note: If these stereo master SOLO switches are not pressed, and no other solos are active, then no signal will feed the AFL or PFL busses and you will be monitoring silence.

SOLO Add When depressed, the **SOLO Add** switch allows multiple SOLO switches to be selected.

AFL/PFL Selector By default, you will be monitoring channels or outputs in AFL on the local monitor and headphone outputs when you press a SOLO switch. Press **input PFL** to force all input (input channels and the stereo direct input) solos into PFL mode. Press **output PFL** to force all output (16 mix bus and stereo master) solos into PFL mode. Select both switches to force PFL solos across the console.

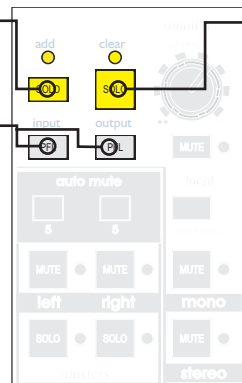

SOLO Clear The **SOLO Clear** LED illuminates to show a solo is active. Press the **SOLO Clear** switch to cancel all active solos. Note: Solo Clear does not apply to the stereo master left and right solos as these are mechanically latching switches.

Solo Hierarchy

In addition to the master AFL/PFL selector, Siena's hierarchical solo system allows you to quickly switch between monitoring say an input channel in PFL and a mix bus output in AFL. The local monitor and headphone outputs are controlled according to the following solo hierarchy:

1. Input channels and the stereo Direct Input solos take highest priority.
2. The 16 mix bus master solos take second priority.
3. The stereo master left and right solos take lowest priority.

To best explain the power of this system, let's take a typical operating scenario. For example, you may wish to set up the console so that you can PFL any input channel quickly, but still monitor your mix bus auxiliary sends or group masters in AFL. Select the **input PFL** switch to force all input channel and the stereo direct input solos into PFL mode. Also check that the **output PFL** switch is not selected so that all output solos remain in AFL. Turn on the **Solo Add** switch to enable additive solo selections. Finally, turn on the stereo master left and right SOLO latching switches and check that you are now monitoring the stereo master output post fader (in AFL).

Now press any of the 16 mix bus master SOLO switches. Since the mix bus master solos are higher in priority than the stereo master solos, you will be monitoring only the output of the mix bus (in AFL) even though all three SOLO switches remain illuminated.

Then select a SOLO switch on any input channel. This time the hierarchical system works to provide you with monitoring of the input channel only. The input channel is monitored pre fader (in PFL) since this was the selection made from the master AFL/PFL selector.

If you now deselect the input channel solo, you will go back to monitoring the mix bus output in AFL.

Remember that you can also use **SOLO Clear** at any time to clear down all selections except the stereo master solos. This allows you to quickly revert to monitoring the stereo master output.



Master Section: Stereo Master & Monitoring Controls



HELIX Digital Equaliser Solo Tracking System



The Siena console features a Solo Tracking System which allows any of the 16 mix bus master or stereo master solos on the console to trigger auto solo messages on the Klark Teknik DN9340 (HELIX) digital graphic equaliser. This unique interface allows engineers to quickly view the equaliser settings for a mix output on the HELIX master display simply by pressing the corresponding mix solo switch on the console.

Note: the Solo Tracking System supports the Klark Teknik DN9340 (HELIX) digital graphic equaliser only. Multiple Helix units may be linked together to provide enough digital equalisers for all 16 mix bus and stereo master outputs as required. Please refer to the HELIX Operator's Manual for more details on configuration.

The console is connected to the master HELIX equaliser system using the RS-232 (9-pin) data port located on the lower rear connector panel. The data LED is not normally lit but will illuminate briefly each time a mix bus or master solo is triggered.

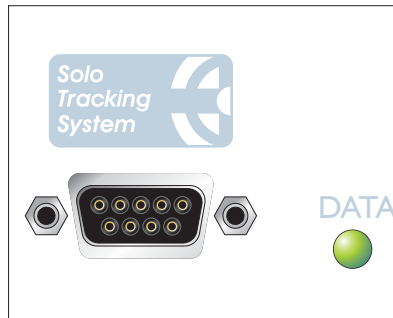

Pressing any one of the 16 mix bus master or left/right stereo master solo switches on the console triggers the corresponding auto solo message to the HELIX. This results in the relevant EQ being automatically shown on the HELIX master display allowing you to now quickly view and adjust the master's EQ settings.

Note: the Solo Tracking System responds to the console's **Solo Clear** and the hierarchical system. For example, when you select the stereo master left SOLO switch, the HELIX will respond by displaying equaliser settings for the stereo master output. Now select one of the 16 mix bus master solos. As these are higher priority, the system cancels the stereo master solo trigger and the HELIX will now display equaliser settings for the chosen mix bus output. If you then deselect the mix bus master solo, the system reactivates the stereo master solo returning the Helix display to show EQ settings for the stereo master.

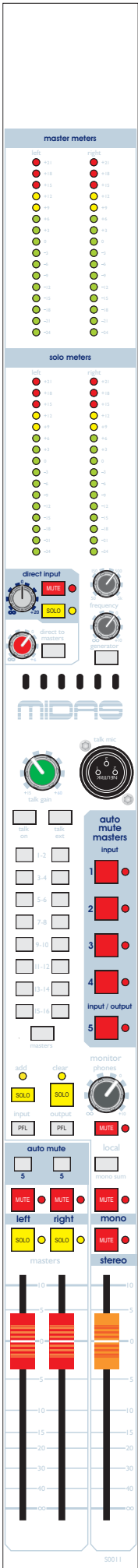

Master Section: Stereo Master & Monitoring Controls

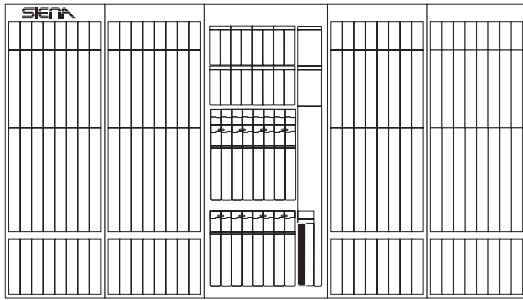

Stereo Master Output Controls

In addition to the console's 16 mix bus outputs, the Siena provides a stereo master typically used to generate the front of house (FOH) mix, if required. Independent controls are provided for the left and right sides of the stereo master retaining ultimate control at all times.

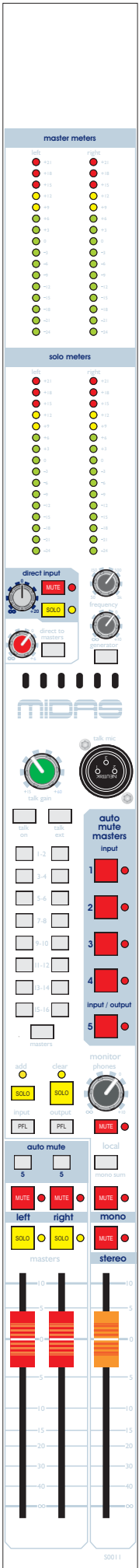

Auto Mutes The two auto mute 5 switches are used to assign the left or right stereo master output mute to auto mute group 5.

Solos The two **SOLO** switches route the left and right stereo master signals onto the stereo AFL and mono PFL busses. The solo LED indicators illuminate to show that the master solos are active. Depending on the PFL selector in the master section, you may be listening to the master output signal in AFL or PFL on your local monitoring or headphone outputs.

Note: the left and right master SOLO switches are mechanically latching and are not affected by the **SOLO Clear** function. By selecting these two switches you can set the default solo state to monitor the stereo master output whenever other solos are cleared.

The two stereo master SOLO switches may also trigger auto solo messages on an external Helix digital equaliser via the console's Solo Tracking System. For more details, please refer to Page 25.

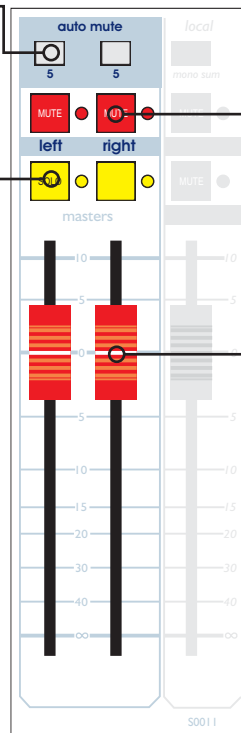

Mutes The two **MUTE** switches mute the left and right stereo master signals post fader. (i.e. signal is muted at all points except the master insert send and PFL bus). The mute status is indicated by the corresponding mute LED. Note: the mute switch may be controlled by Auto Mute master 5, see left.

Faders The two stereo master faders provide continuous adjustment of the left and right master outputs from off (-inf) to +10dB.



Setting up the Siena

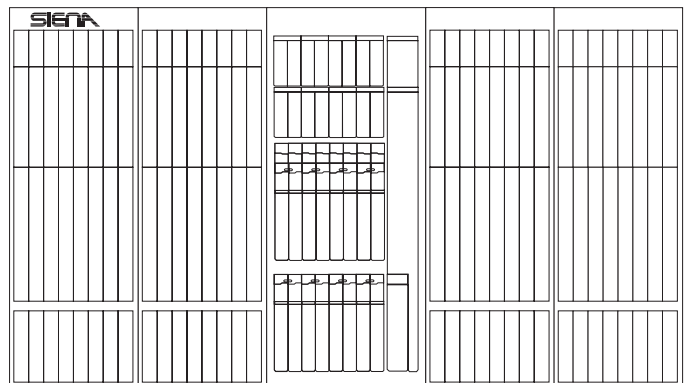

The Siena has been designed with real world sound engineering in mind. With its flexible routing and feature set, the console is as happy running the front of house (FOH) mix as it is providing monitor mixes for the artists on stage.

In this section of the manual, we will introduce some of the basic operating principles of the Siena console, and discuss some typical operating scenarios and the best way to approach them.

Setting the Correct Input Gain

The Siena's input channel has a mono microphone and line input. Gain is provided on these channels to allow the operator to obtain the optimal signal for the system.

Microphone Gain	+15dB to +60dB (0dB to +45dB with pad switch enabled)
Mono Channel Line Gain	0dB to +45dB (-15dB to 30dB with pad switch enabled)

Each channel of the Siena includes an in-line channel LED meter indicating the channel level (measured after the channel insert and EQ but before the channel fader). With the insert and EQ disabled, the in-channel meter will show the level at the input in four stages:-

-18dB	- Signal Present
0dB	- Normal operating level
+12dB	- High Signal Level
+18dB	- 3dB before channel overload (clipping)

The input gain of the channel can be used to obtain the best operating level for the console. Too small a signal level (too little gain) and the best signal to noise ratio will not be achieved; too high a signal level (too much gain) and there is the chance of overloading the channel causing distortion.

Clearly, the gain should be positioned between these two points, to gain an optimal signal to noise ratio without overloading the channel. The ideal level for input channels would be around +6dB with occasional illumination of +12dB.

Leaving Enough Headroom

A channel signal is only permitted to swing high and low by an amount fixed by the power supply. If the maximum output of the Siena channel strip is +21dBu (0dBu = 0.775 volts RMS) then imagine the following situation:

Headroom is the amount of spare 'swing' available to the system. If 6dB headroom was desired at all times, a maximum level of +15dB is required to retain the headroom.

To prevent overload, the gain must be set to a point that even the highest output from the microphone during sound check has some headroom left to prevent any surprises during the show!

The consoles Busses (e.g. Left and Right Main buss) are the point where all channel signals are summed together. In normal operation, it is unlikely that all channels will receive the same signal at the same time so typically when 48 channels are summed together a gain of around 6 to 9dB will be seen. It is important to leave some headroom in the summing amplifiers so that they do not overload, should the sum exceed the maximum level.

The Effect of EQ

Channel equalisation should be used with care. Boosting or cutting equaliser bands can make monitoring your actual input level very difficult. Excessive boosting of EQ (+15dB is available on each band) will have the same effect as applying more gain to the input, taking up valuable headroom. Consider backing off the channel gain when using large amounts of boost (if you have to use large amounts of boost) to retain a sensible level at the output.

Excessive EQ cut can have a similarly undesirable effect. If a large amount of signal is cut in the equaliser section, gain may be used to 'make up' the level lost in the equaliser. However, the input pre-amplifier still has the same amount of available headroom. If gain, added to 'make up' the loss in the equaliser, exceeds the maximum level into the microphone pre-amp then the channel won't appear to be overloaded but the microphone pre-amp will. Turning off the equaliser will reveal the true story, whereby the microphone pre-amp may be overloaded. It is worth considering whether such large amounts of EQ cut is really required, or whether it is being used rather more as a volume control (in which case the input gain could be set to a normal operating level and the output adjusted on the channel fader).

TIP: You can monitor the level pre-EQ and post-EQ using the in-channel LED meter by switching the EQ in and out during sound check.

Using Dynamics Processing to Control Gain

When working with signals that are constantly at a high level, the channel gain can accommodate these signals with ease. When working with varying signals (such as the vocals) it may be desirable to reduce the dynamic range of the signal so that the loud parts aren't so loud (and don't overload your channel input) and the quiet bits aren't too quiet (so the signal to noise ratio would be increased).

Limiters and Compressors have a similar function which is to reduce the dynamic range of a signal. The means by which they do this won't be discussed here but, these devices have the ability to reduce the level of loud signals automatically and also raise the gain to 'make up' the level as desired. The channel gain can now be set with adequate headroom to accommodate both loud and quiet signals and the compressor can reduce the dynamic range and 'make up' any reduction in level. By inserting such a device into the channel's insert point you have the ability to remove the guesswork from setting your system gain.

However (and this is a big however), there are still sources of potential problems. The Siena is able to operate at levels up to +21dBu on both the insert send and return. If the maximum input level of the compressor was less than +21dBu then it is possible to overload the input of the compressor. The only way to resolve this situation would be to drop the channel input gain so that the input level of the compressor was not being overloaded. Bear in mind however, the level returned from the compressor would also be lower than +21dBu and excessive use of the compressor 'make up' gain would overload the output of the compressor!

What is Unity Gain?

Unity gain is a gain of 1 (i.e. no gain or attenuation is applied to a signal).

If a signal entered a mono line level input of the Siena at 0dBu and the gain was set to +15dB (an internal 15dB attenuation sets the net gain to 0dB), then the signal was routed to each output at 0dB, the channel fader was set to 0dB and each output fader was set to 0dB, the output should be 0dBu (or unity). Some console manufacturers mark the 0dB level of their faders and pots 'U'.

Simple. But that's just one signal. If we have two 0dBu signals entering the Siena (assuming they are coherent - i.e. the same level and phase) to be summed in the busses, the output would no longer be 0dBu.

Simply,

$$\begin{aligned} 0\text{dBu} &= 0.775 \text{ volts} \\ 0.775 \text{ volts} + 0.775 \text{ volts} &= 1.55 \text{ volts} \end{aligned}$$

$$1.55 \text{ volts is } 0.775 \text{ volts } +6\text{dB (or a gain of 2)}$$

To retain an output of 0dBu (our previous unity level) each input must be reduced.

$$\begin{aligned} 0.775 \text{ volts} / 2 &= 0.3875 \text{ volts} \\ 0.3875 \text{ volts is } 0.775 \text{ volts } -6\text{dB (or a gain of } 1/2) \end{aligned}$$

So each fader must be reduced to -6dB to retain the unity gain level of 0dBu on the console output. When using four inputs at 0dBu, the faders must be reduced to -12dB. Real life signals are not continuous, but the principal is the same. If you have a sinusoidal input that is nominally 0dBu on all 48 inputs with the channel faders at 0dB, the output is likely to be well above the 21dBu maximum output of the console and leave no headroom spare. With real world signals, 48 channels summed together will give around 6 to 9dB gain because it is unlikely that all 48 channels will receive the same signal at the same time. Instead signals will occur at different times, and there will be cancellation due to phase and frequency differences.

Signal Processing and Amplifiers

The final links in the system tend to be graphical equalisers, loudspeaker processors and finally amplifiers and speakers.

Graphical equalisers have the same problems as the Siena's EQ. If excessive boost is applied to the signal, the graphic equaliser's output may be overloaded. If, the output of the Siena is higher than the maximum input level of the graphic, the input of the graphic may be overloaded.

Loudspeaker processors have similar problems. If the input level to the processor is too high, the input may be overloaded and introduce distortion into the outputs (and to the speakers!). In addition to this, any boost on the processors outputs (say you want 3dB more bass) will cause that output to overload earlier (in this case 3dB before the other outputs).

Finally, amplifiers can introduce the most interesting results.

An amplifier has a sensitivity. That is, an input signal level that causes the amplifier to produce it's maximum output level. For many amps this is 0dBu (0.775 volts RMS), others use 0dBV (1 volt RMS) others use different levels. Beyond this sensitivity, the amplifiers output will not be able to produce any more power and 'CLIP' (usually indicated by some serious looking red lights). Sending +21dBu level from the Siena will clip the output of most amplifiers causing damage to your loudspeaker system.

There are a number of solutions to this problem:

Reduce the amplifiers input attenuators to a level where the amplifier and console clip at the same point.

E.g. The input sensitivity is 0dBu, setting the input attenuator on the amplifier to -21dB would mean that the console would clip at the same time as the amplifier. So operating the console sensibly the amplifier should never be clipped. The console led Meters will also accurately show the Available headroom left in the entire system.

-21dB may not be a sensible level to set as many operators choose not to run the output of the console so high. That is personal choice.

Run the output of the console at a level below 0dBu

This solution means that you won't get full benefit of the console, and may suffer a reduced signal to noise ratio especially when running over long signal cables. But the amplifiers should be saved from clipping.

As with many things in the audio world, use your ears. If something sounds distorted check:

Input Gain too high?	(lower input gain and check)
EQ Too Much Boost?	(disable eq and check)
EQ Too Much Cut coupled with a High Input Gain?	(disable eq and check)
Too High a level into Inserted Processor?	(disable insert and check)
Clipping Loudspeaker controller or Amplifiers	(check CLIP lights on amps etc.)

Busses and Routing

Siena has a master stereo bus plus 16 mix bus outputs which may be used as auxiliary sends or group outputs depending on the application of the console. This generic approach to the mix bus structure enables the console cover a wide range of applications. Here are two typical examples:

Monitors (Creating Auxiliary Sends)

When using the Siena purely as a monitor desk, you will want to generate as many auxiliary sends as possible to feed each artist's monitoring. In addition, you may require both mono and stereo monitor mixes to feed a mixture of floor monitors and wireless in-ear monitoring. By configuring any odd/even pair of the Siena's mix busses for stereo operation, you have complete flexibility over the console layout. A typical layout may be as follows:

Mix Bus	Format	Application
1-8	mono	sends to eight mono floor monitors.
9 & 10	mono	sends to an external effects unit (e.g. reverb).
11-16	stereo	sends to three stereo wireless in-ear monitor systems.
Master Stereo	stereo	may remain unused, or generate an additional stereo monitor send to the stage.

You may now use the mix bus master controls to adjust the level of each artist's send on the master fader, mute single or multiple feeds and solo your sends on local monitoring or headphones in AFL or PFL. Use the mix bus master insert sends and returns to apply any external master processing (e.g. a protection limiter) to individual sends.

Tips

* The stereo **direct input** provides an additional input to the console. A common application is to use the direct input as a stereo effects return, which saves using two input channels for this purpose. For example, connect the output of your external reverb unit to the console's direct input. Now use the Direct Input Level to Mix controls, located above the mix bus master faders, to add reverb onto each artist's send.

* You may wish to listen to your mono floor monitor feeds on a separate loudspeaker to your stereo in-ear monitoring so that you know what the artist is hearing from each system. Connect a pair of stereo speakers to the **Local Monitor L/R** output and a separate mono speaker to the **Local Monitor M** output. Now solo the mix bus masters feeding both the in-ear monitoring and floor monitors. Using the mono and stereo local monitor MUTE switches, you will now be able to mute the floor monitor speaker to listen to the stereo in-ear monitor feed or vice versa.

* The Siena provides five **auto mute** groups to provide easy muting of similar channels. For example, during a live concert, there may be one song where most of the band will leave the stage. During this part of the show, monitor sends are only needed for one or two performers. By selecting auto mute 5 on all of the other band members' auxiliary send masters, you may mute these monitor feeds with one switch press auto mute master 5.

Busses and Routing

Dual Purpose Front of House (FOH) and Monitor Applications

With its flexible routing and feature set, the Siena is happy to run both the front of house (FOH) mix and provide monitor mixes for the artists on stage. In this dual purpose application, you will want to use some of the 16 mix busses, as above, to generate your monitor feeds to the stage, while the remaining busses can be used to generate audio sub groups.

The master controls for mix outputs 9-16 vary slightly from those for mix outputs 1-8. This is due to the fact that mix bus outputs 9-16 may be routed, and panned, onto the stereo master bus. This makes mix busses 9-16 ideal for use as group outputs as they may be output separately from the console and/or summed onto the stereo master for a FOH mix. For these reasons, use mix busses 1-8 for auxiliary sends and 9-16 to create audio sub groups when working in a hybrid FOH/Monitor application. A typical console layout may be as follows:

Mix Bus	Format	Application
1-2	stereo	send to one stereo wireless in-ear monitor feed.
3-7	mono	sends to five mono floor monitors.
8	mono	send to an external effects unit (e.g. reverb).
9-16	stereo	four stereo group outputs.
Master Stereo	stereo	summed from the group outputs (mix busses 9-16) and/or input channels to create the FOH mix.

Group Outputs Typical Applications

Applications for groups vary, but include:

Sub mixes

Sub mixes are a common way of saving time (and possibly embarrassment) when using a large number of microphones. For example: multiple microphones for Choirs, Drum Kits/Percussion, Orchestras, etc . . .

Typically, the sub mixes will probably be stereo so switch your chosen mix bus masters (e.g.9-16) into stereo mode using the recessed stereo switches located beside the mix bus master faders.

Each input channel to be sub mixed should be routed to the mix bus send ONLY (i.e. not to the stereo master). Remember to set both the level and pan on the input channel send. The channel fader sets the relative level between the channels in the sub mix.

The group masters (e.g. mix bus masters 9-16) should then be routed to the stereo master bus and panned L-R as required. The sub mix is now set up.

The group master controls (mix bus masters) can now be used to control the overall level of the sub mix, mute the sub mix output or solo the sub mix signal.

Note: muting the sub mix is not the same as muting the input channels, as other input channel sends remain active. If channels within a sub mix are required to be muted, use the auto mute facility.

Master EQ/External Signal Processing

Often, it is either too expensive or undesirable to apply signal processing to each channel individually (for example: compression on a whole choir, graphic eq on a number of microphones, etc...).

Set up a sub mix, as described above, to group similar signals together. Now the desired external processor can be inserted into the group (mix bus master) insert send and return to apply processing to the sub mix.

Alternative Outputs

When mixing for a number of speakers in a venue, it may be necessary to generate separate mixes with different levels or processing.

Route the input channels to the chosen mix bus sends, let's say mix busses 9 and 10 and adjust the channel send and fader controls.

Make sure the groups (mix bus masters) are NOT routed to the stereo master output. The group outputs (e.g. mix bus 9 and 10) should then be wired into the amplification feeds to the speaker systems.

You may now control the separate mixes using the channel mix sends and master mix bus controls.

Busses and Routing

Auxiliary Sends Typical Configuration

When determining how many mix busses you wish to use for auxiliary sends, you may wish to consider the following. We've also provided some recommendations on how to configure each send, depending on its application.

Application	Pre/Post Fade	Reason
Artist Monitor Sends	Pre (Post EQ)	The level in the monitor stays constant so that the engineer can change the FOH level without affecting the performer.
Effects Sends	Post	The level sent to the effects is proportional to the level on the fader so the balance between wet (processed) and dry (un-processed) sound stays the same even when the channel level is changed.
Multitrack Recording or Monitors from FOH	Pre (Pre-EQ)	The recording is made at constant level without EQ so that these changes can be set in post-production when more time, and a better listening environment are available. (You can also use the channel insert send as a Direct Out for this application but note that the output will be at unity).





Functional Block Diagrams

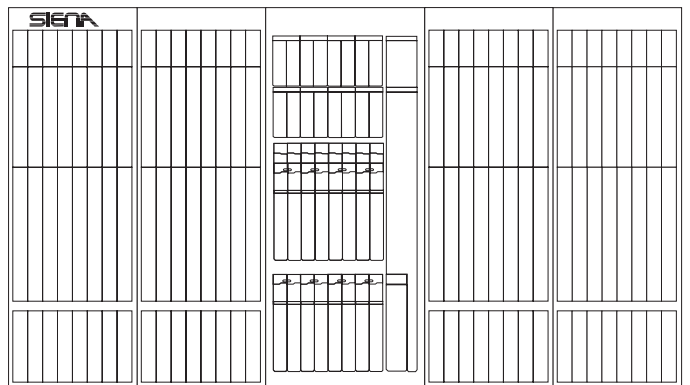

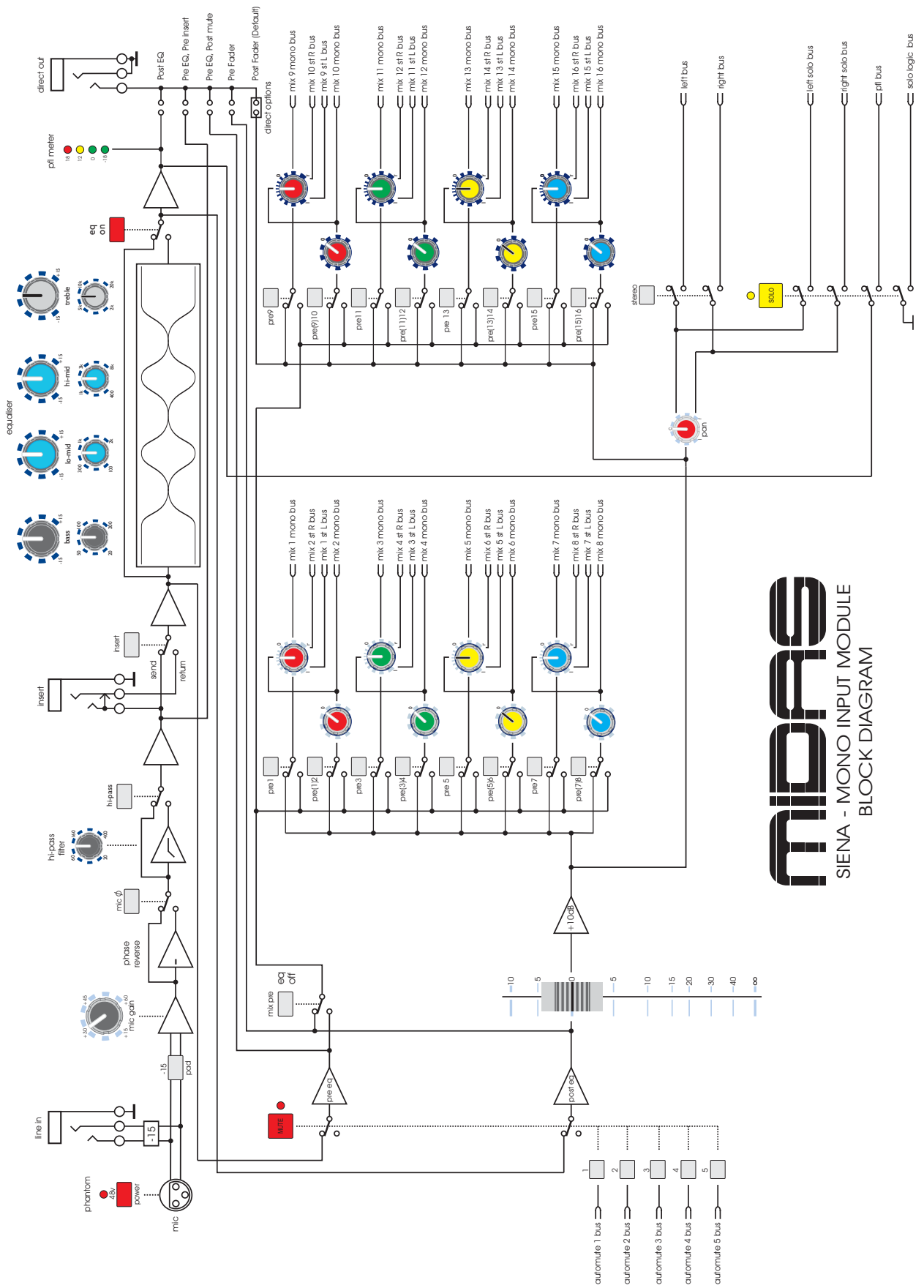

SIENA - MONO INPUT MODULE BLOCK DIAGRAM

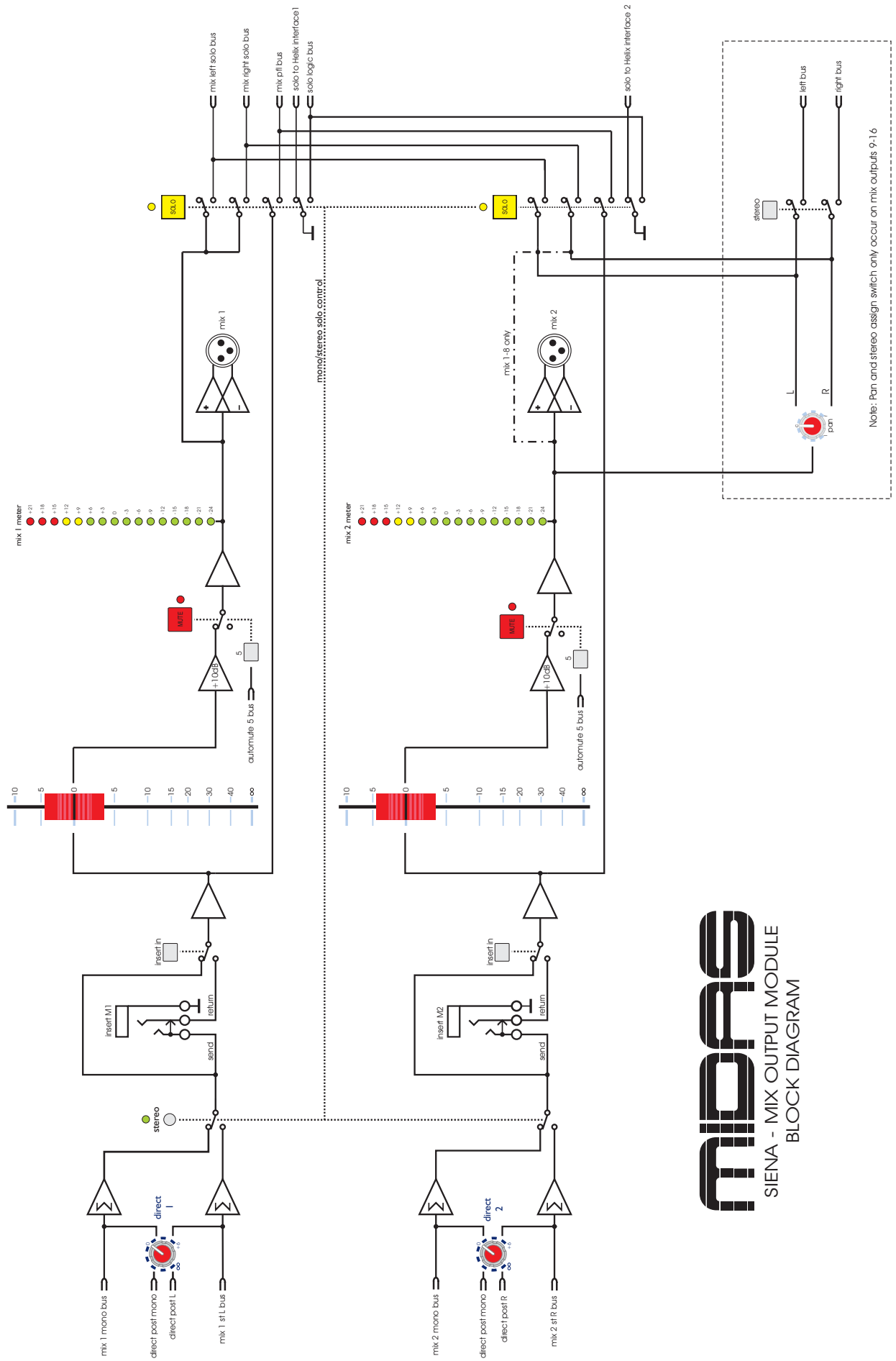

MIDPFS

SIENA - MASTER MODULE BLOCK DIAGRAM

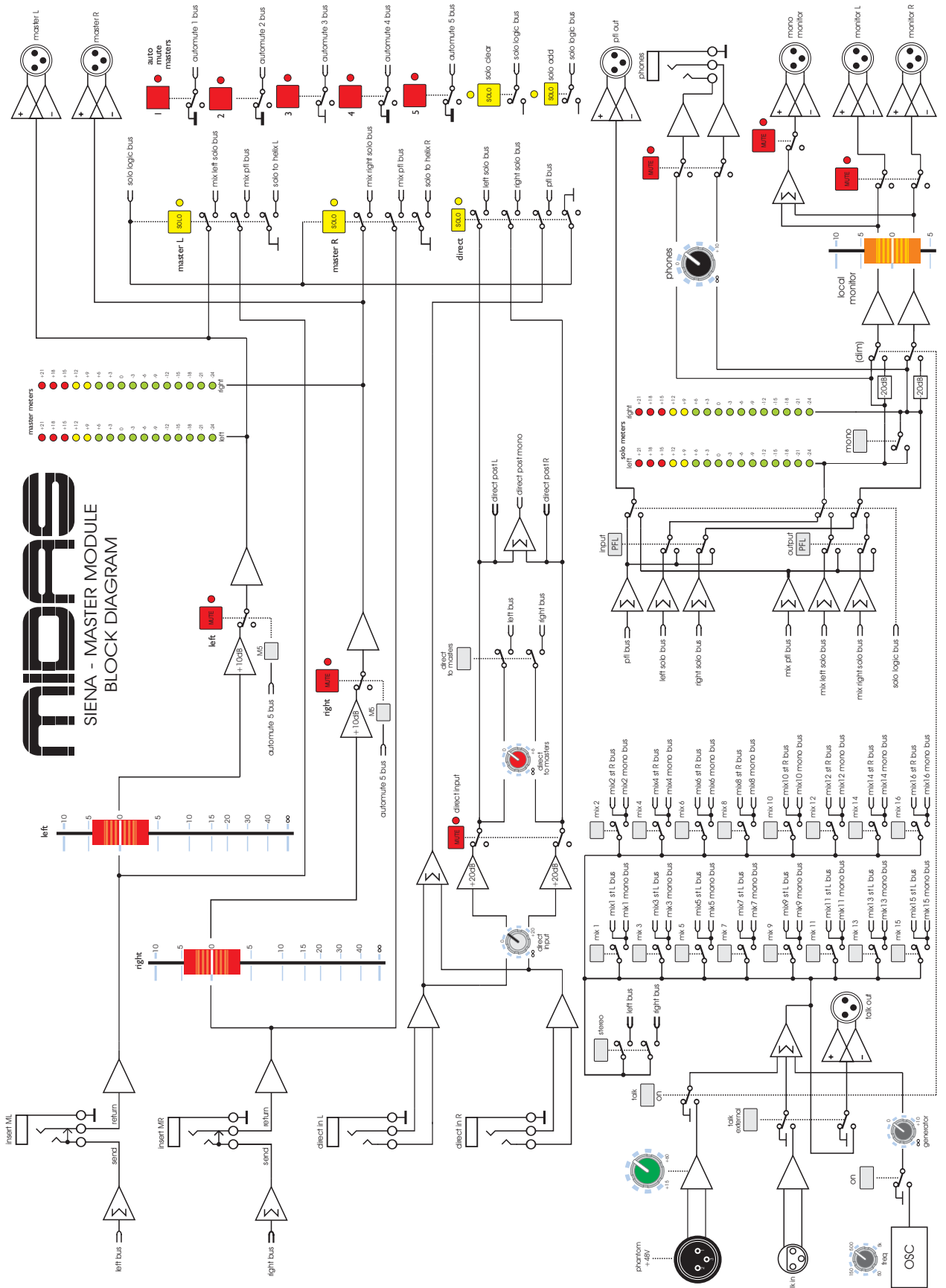



Dimensions and Weights

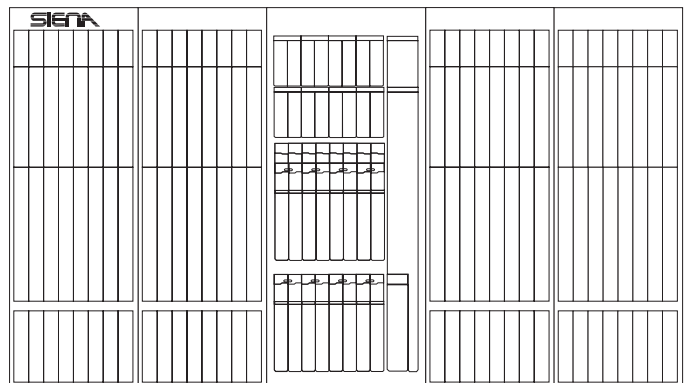

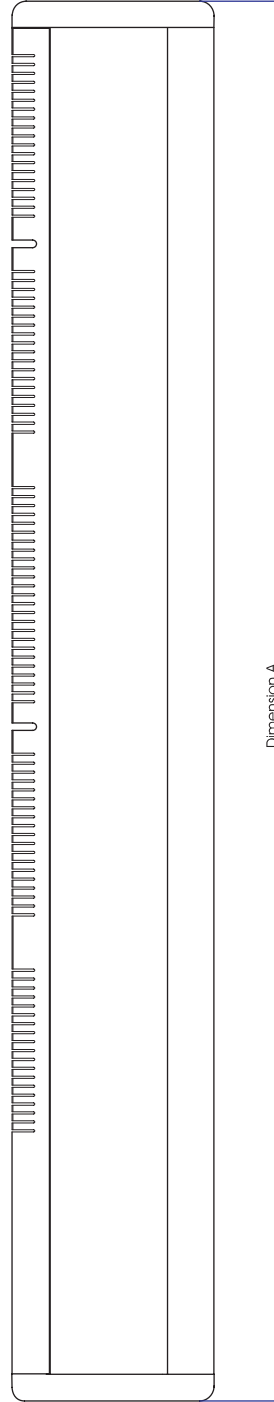
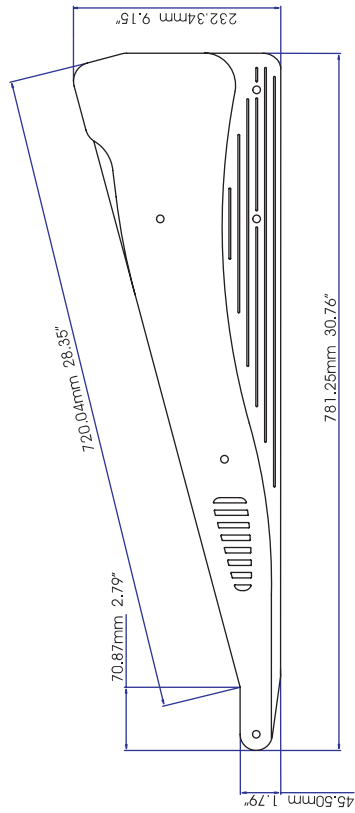

Dimension A:

Channel	Dimension A	Weight*	Weight*
24 channel	1085.00mm	42.72"	45 kg
32 channel	1327.00mm	52.24"	55 kg
40 channel	1569.00mm	61.78"	65 kg
48 channel	1811.00mm	71.30"	75 kg
56 channel	2053.00mm	80.83"	85 kg
64 channel	2295.00mm	90.35"	95 kg

* estimated weight out of flightcase.



Rear panel Description

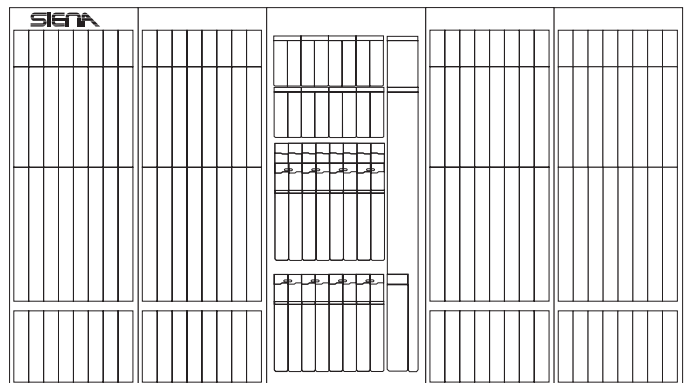

Rear Panel Description

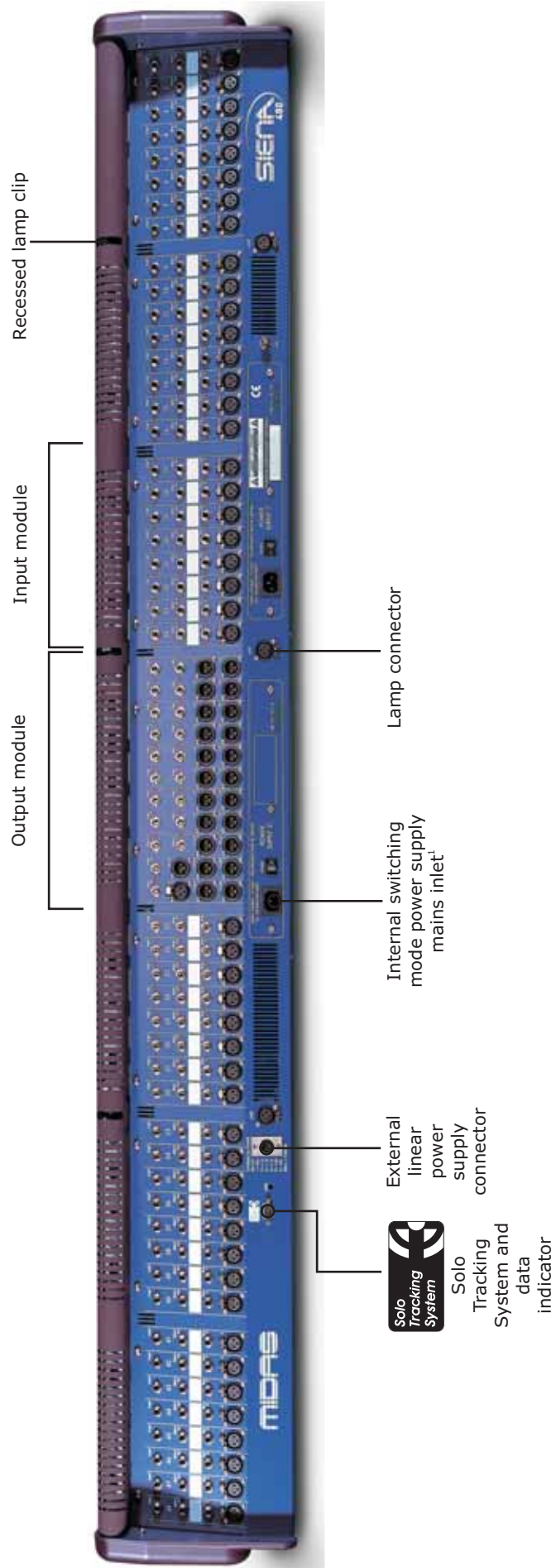

Model shown Siena 480
 1 Refer to specifications for PSU fitting option



Specification and Features

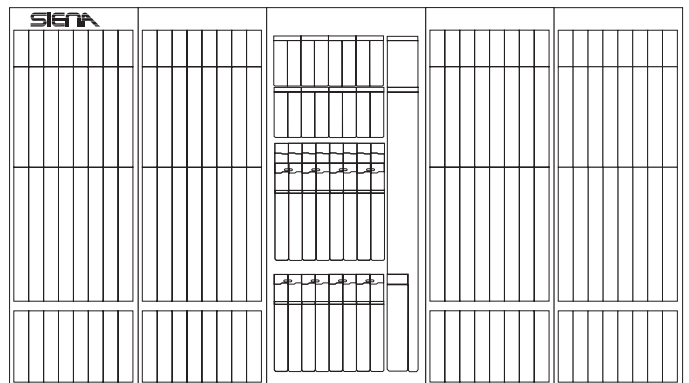

Siena Features

The following list of features is based upon the 48-channel frame size console.

The 48-channel Siena features:

- 48 mono input channels
- 16 Mix Bus Outputs
- Mono Channels: 4 Swept Frequency Bands (Treble, Hi Mid, Lo Mid, Bass)
- 48 volt phantom power independently switched on each channel (always enabled on talk mic)
- Hi-Pass filter on all inputs (Variable 20Hz to 400Hz)
- Signal Generator
- 48 Switched Channel Inserts
- 16 Switched Mix Bus Inserts
- 48 Direct Outputs (Five jumper selectable source options)
- Solo Tracking System

	Type	Connector	Impedance	Balanced	Level Nom(Max)	No.
Inputs	Microphone	XLR(f)	1k5 ohm	Yes	Variable (+21dBu w/pad)	48
	Ch Line Input	1/4" TRS Jack	10k ohm	Yes	Variable (+36dBu w/pad)	48
	Direct Input	1/4" TRS Jack	10k ohm	Yes	Variable (+26dBu)	2
	Talk	Mic XLR(f)	1k5 ohm	Yes	Variable (+6dBu)	1
	Talk Input	XLR(f)	10k ohm	Yes	0dBu (+21dBu)	1
Outputs	Direct Out	1/4" TRS Jack	100 ohm	Imp Bal.	0dBu (+21dBu)	48
	Mix Out	XLR(m)	50 ohm	Yes	0dBu (+21dBu)	16
	Talk Out	XLR(m)	50 ohm	Yes	0dBu (+21dBu)	1
	Master Out	XLR(m)	50 ohm	Yes	0dBu (+21dBu)	2 (LR)
	Monitor Out	XLR(m)	50 ohm	Yes	0dBu (+21dBu)	3 (LRM)
	PFL Out	XLR(m)	50 ohm	Yes	0dBu (+21dBu)	1
	Headphones	1/4" TRS Jack	To drive headphones > 100 ohm		+10dBu (+21dBu)	1
Inserts	Input	1/4" TRS Jack	50/10k ohm (s/r)	No	0dBu (+21dBu) (send/ret)	48
	Mix	1/4" TRS Jack	50/10k ohm (s/r)	No	0dBu (+21dBu) (send/ret)	16
	Master	1/4" TRS Jack	50/10k ohm (s/r)	No	0dBu (+21dBu) (send/ret)	2
Total XLR input count			50			
Total Jack input count			50			
Total XLR output count			23			
Total Jack output count			49			
Total insert count			66			

XLR

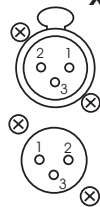

- Pin 1 - Screen/Ground
- Pin 2 - Hot Signal
- Pin 3 - Cold Signal

Note: Sockets are viewed from the front face.

Quarter Inch Jack

	TRS Signal	TRS Insert	TRS Headphone
Sleeve	Screen/Ground	Screen/Ground	Screen/Ground
Ring	Cold Signal	Insert Return	Right
Tip	Hot Signal	Insert Send	Left



Siena Specification

Internal Power Supply		
	Type	Switching
	Line Voltage	90 - 240V AC
	Line Frequency	50/60Hz
Input Impedance		
	Microphone	1k5 ohm Balanced
	Line	10k ohm Balanced
Input Gain (all faders at 0dB)		
	Microphone	Continuously variable from +15dB to +60dB
	Microphone + Pad	Continuously variable from 0dB to +45dB
	Channel Line	Continuously variable from 0dB to +45dB (-15dB to +30dB Pad enabled)
	Direct Inputs	Continuously variable from off to +20dB
Maximum Input Level		
	Mic	+6dBu
	Mic + Pad	+21dBu
	Channel Line	+21dBu (+36dBu pad enabled)
CMR at 100Hz		
	Microphone (Gain +40dB)	Typ 95dB
	Microphone + Pad (Gain 0dB)	Typ 80dB
	Line (Gain 0dB)	Typ 80dB
CMR at 1kHz		
	Microphone (Gain +40dB)	Typ 95dB
	Microphone + Pad (Gain 0dB)	Typ 80dB
	Line (Gain 0dB)	Typ 80dB
Frequency Response (20Hz to 20kHz)		
	Microphone to Mix	+0 to -1dB
Noise 20Hz to 20kHz		
	Microphone EIN ref. 150 ohms (Gain +60dB)	-129dBu
System Noise (20Hz to 20kHz)		
	Summing Noise (48 channels routed with faders down)	-80dB
	Line to Mix Noise (48 channels routed at 0dB, pan centre)	-75dB
Distortion at 1kHz		
	Microphone to Mix (Gain +40dB, 0dBu output)	<0.03%
Crosstalk at 1kHz		
	Channel to Channel	< -100dB
	Mix to Mix	< -85dB
	Channel to Mix	< -85dB
	Max. Fader Attenuation	> 100dB
	Max. Mute Attenuation	> 100dB
Output Impedance		
	All Line Outputs	50 ohms Balanced Source to drive > 600 Ohms
	Direct Output	100 ohms impedance balanced
	Insert Output	50 ohms unbalanced
	Headphones to drive	> 100 ohms
Maximum Output Level		
	All Line Outputs	+21dBu
	Headphones	+21dBu
Nominal Signal Level		
	Microphone	-60dBu to 0dBu
	Line	0dBu
	Headphones	+10dBu

Equalisation

Hi-pass slope	12dB/octave	
Treble Band	Cut/Boost	+/-15dB
	Frequency range	2kHz to 20kHz
Hi Mid Band	Cut/Boost	+/-15dB
	Frequency range	400Hz to 8kHz
	Bandwidth	1 Octave
Lo Mid Band	Cut/Boost	+/-15dB
	Frequency range	100Hz to 2kHz
	Bandwidth	1 Octave
Bass Band	Cut/Boost	+/-15dB
	Frequency range	20Hz to 400Hz
	Bandwidth	1 Octave

Power Supply Information

The number of power supplies shipped as standard with the Siena varies with the frame size as follows:

Channels	Internal	External	Redundancy
24	1	0	NO
32 - 56	2	0	YES
64	2	1	YES

The internal supplies on the 64 channel Siena should be switched on at approximately the same time so that excessive load is not applied to any single supply.

The external power supply can be used to add or increase redundancy or to replace the internal supplies. The external supply has a "daisy chain" facility (as shown below) allowing for a number of power supplies to be used together adding redundancy to the system in the event of a power supply failing.

Connection	6 Pin Male XLR
Pin 1	0V Analogue
Pin 2	+18V Analogue
Pin 3	-18V Analogue
Pin 4	+12V Gooseneck Light
Pin 5	+48V Phantom
Pin 6	0V Gooseneck Light
Case	Chassis

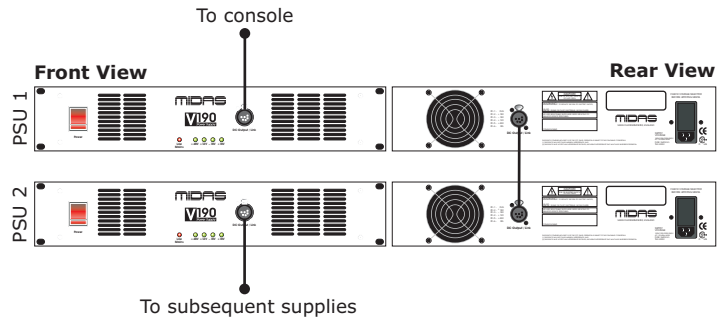

Under NO circumstances should the Venice series power supply be used with the Siena. Only the Midas V190 Linear External Power Supply is approved for use with Siena consoles.

Servicing and Maintenance



Both the Siena and the Midas V190 linear external power supply both contain potentially lethal voltages and should only be serviced by authorised Midas service agents. In the event of malfunction, please refer servicing to qualified personnel. Contact your Midas dealer for more information.

Due to a policy of continual improvement, Midas reserves the right to alter the specification and performance at any time without prior notification.

